

# ROCKSHOX

SUPER  
DELUXE

2023+  
Super Deluxe



SERVICE MANUAL



# SAFETY FIRST!

We care about YOU. Please, always wear your safety glasses and protective gloves when servicing RockShox products.

Protect yourself! Wear your safety gear!

## **⚠️ WARNING - PRESSURIZED DEVICE**

Suspension products may contain pressurized air, nitrogen, springs, and oil.

Always wear certified safety glasses (ANSI Z87.1, EN166 EU) when performing any service on a suspension product (suspension fork, rear shock, seatpost).

Failure to wear proper safety glasses can result in **SERIOUS INJURY OR DEATH.**

## RockShox Service

We recommend that you have your RockShox suspension serviced by a qualified bicycle mechanic. Servicing RockShox suspension requires knowledge of suspension components, as well as the use of specialized tools and lubricants/fluids. Failure to follow the procedures outlined in this service manual may cause damage to your component and void the warranty.

Visit [www.sram.com/service](http://www.sram.com/service) for the latest *RockShox Spare Parts Catalog* and technical information. For order information, please contact your local SRAM distributor or dealer.

Information contained in this publication is subject to change at any time without prior notice.

Your product's appearance may differ from the pictures contained in this publication.



For recycling and environmental compliance information, please visit: [www.sram.com/en/company/about/environmental-policy-and-recycling](http://www.sram.com/en/company/about/environmental-policy-and-recycling).

## Suspension Safety Precautions and Warnings

### SAFETY INSTRUCTIONS

To avoid serious injury or death, you **MUST** understand and follow the safety information in this document.

#### **⚠ WARNING - PRESSURIZED DEVICE**

Suspension products may contain pressurized air, nitrogen, springs, and oil.

Always wear certified safety glasses (ANSI Z87.1, EN166 EU) when performing any service on a suspension product (suspension fork, rear shock, seatpost).

DO NOT attempt to disassemble a suspension product before the product is fully depressurized. Follow depressurization procedures and remove the air valve as instructed, before attempting disassembly of a suspension product.

When performing service on a suspension product, keep your eyes, face, and body away from any part or lubricant that can suddenly eject under high pressure. DO NOT direct any pressurized suspension part at a person.

DO NOT attempt to puncture, crush, or incinerate any assembled suspension product.

**Failure to follow these preventative measures can result in SERIOUS INJURY OR DEATH.**

#### **⚠ WARNING - CRASH HAZARD**

Parts must be tightened to the specified torque.

To avoid separation of parts, threadlocker must be applied as instructed. Failure to apply threadlocker could result in separation of the parts.

Retaining rings must be fully seated in the retaining ring groove. Confirm the retaining ring is fully seated in the retaining ring groove after installation.

Do not use vinegar of any type to clean any part of a RockShox suspension product. Vinegar can cause permanent damage to parts which can, over time, result in product structural failure.

**Failure to follow these preventative measures can result in SERIOUS INJURY OR DEATH.**

#### **⚠ WARNING**

Do not ingest oil, fluid, grease, lubricant, or cleaner. Ingestion could lead to SERIOUS INJURY OR DEATH. Seek immediate medical attention if any oil, fluid, grease, lubricant, or cleaner is ingested.

#### **⚠ CAUTION**

Suspension products may contain lubricants which can lead to skin irritation. Always wear nitrile gloves when servicing suspension products. Failure to properly protect your skin can result in irritation. Seek medical attention if your skin is adversely affected by any suspension oil, fluid, grease, lubricant, and/or cleaner.

Always wear safety glasses. Do not allow oil, fluid, grease, lubricant, or cleaner to contact your eyes or face. Seek immediate medical attention if irritation occurs.

Use care when working with sharp tools and parts. Never use sharp tools coated with oil and/or grease. Clean and remove all oil and/or grease from your hands and gloves, and tools before working with any sharp tool or part. Failure to do so can result in personal injury.

Place an oil pan on the floor underneath the product during service to catch any drained or spilled fluids. To avoid a slip and fall, and possible injury or harm, immediately clean any oil, fluid, grease, or lubricant from the floor in your work area.

# TABLE OF CONTENTS

<b>ROCKSHOX SERVICE</b> .....	<b>3</b>
<b>SUSPENSION SAFETY PRECAUTIONS AND WARNINGS</b> .....	<b>3</b>
<b>PART PREPARATION AND SERVICE PROCEDURES</b> .....	<b>5</b>
PART PREPARATION .....	5
SERVICE PROCEDURES.....	5
MODEL CODE IDENTIFICATION .....	6
WARRANTY AND TRADEMARK.....	6
RECOMMENDED SERVICE INTERVALS.....	7
RECORD YOUR SETTINGS.....	7
TORQUE VALUES.....	7
PARTS, TOOLS, AND SUPPLIES - COMPREHENSIVE.....	8
<b>EXPLODED VIEW</b> .....	<b>9</b>
2025+ (C2) SUPER DELUXE ULTIMATE RC2T (RS-SDLX-ULT-C2).....	9
2025+ (C2) SUPER DELUXE SELECT+ RCT (RS-SDLX-SELP-C2).....	10
2025+ (C2) SUPER DELUXE SELECT RT (RS-SDLX-SEL-C2).....	11
2025+ (C2) SUPER DELUXE BASE R (RS-SDLX-BSE-C2).....	12
2023-2024 (C1) SUPER DELUXE ULTIMATE DH RC2 (RS-SDLX-ULDH-C1).....	13
2023-2024 (C1) SUPER DELUXE ULTIMATE RC2T (RS-SDLX-ULT-C1).....	14
2023-2024 (C1) SUPER DELUXE ULTIMATE RC2T AIRWIZ (RS-SDLX-ULT-C1).....	15
2023-2024 (C1) SUPER DELUXE SELECT+ RT (RS-SDLX-SELP-C1).....	16
2023-2024 (C1) SUPER DELUXE SELECT R (RS-SDLX-SEL-C1).....	17
SUPER DELUXE (C1-C2) - LINEAR XL AIR CAN (OPTIONAL UPGRADE).....	18
<b>SHOCK EYELET SERVICE - STANDARD EYELET</b> .....	<b>19</b>
MOUNTING HARDWARE REMOVAL (SERVICE AND OPTIONAL BEARING ADAPTER INSTALLATION) .....	19
EYELET BUSHING REMOVAL.....	22
EYELET BUSHING INSTALLATION .....	24
EYELET BUSHING SIZING .....	25
<b>SHOCK EYELET SERVICE - BEARING ADAPTER (23 MM)</b> .....	<b>27</b>
BEARING ADAPTER REMOVAL .....	27
<b>SHOCK EYELET SERVICE - BEARING EYELET MOUNT</b> .....	<b>29</b>
BEARING REMOVAL.....	29
BEARING INSTALLATION .....	31
BEARING EYELET MOUNT - REPLACEMENT.....	35
<b>SUPER DELUXE SERVICE</b> .....	<b>36</b>
<b>50 / 200 HOUR SERVICE</b>	
AIR CAN SERVICE - REMOVAL .....	37
BOTTOMLESS TOKENS AND TRAVEL REDUCER .....	41
AIR CAN SERVICE .....	44
LINEAR XL AIR CAN - OUTER SLEEVE SERVICE AND TUNING.....	48
<b>50 HOUR SERVICE</b>	
SEALHEAD / AIR PISTON SERVICE .....	53
<b>200 HOUR SERVICE</b>	
IFP RESERVOIR SERVICE.....	54
DAMPER BODY SERVICE.....	58
UPGRADE (OPTIONAL) SUPER DELUXE C2 ULTIMATE RC2T RESERVOIR.....	63
AIR PISTON / SEALHEAD SERVICE .....	67
REAR SHOCK SERVICE - ASSEMBLY.....	69
SHOCK ASSEMBLY AND BLEED .....	72
<b>50 / 200 HOUR SERVICE</b>	
AIR CAN INSTALLATION .....	84
<b>MOUNTING HARDWARE - STANDARD EYELET</b> .....	<b>88</b>
MOUNTING HARDWARE INSTALLATION.....	88
<b>UPGRADE (OPTIONAL) - STANDARD EYELET TO BEARING ADAPTER (23 MM)</b> .....	<b>91</b>
BEARING ADAPTER INSTALLATION.....	91
<b>BEARING EYELET MOUNT</b> .....	<b>97</b>
BEARING MOUNT INSTALLATION .....	97
<b>SHOCK INSTALLATION AND SETUP</b> .....	<b>98</b>

# Part Preparation and Service Procedures

## Part Preparation

Remove the component from the bicycle before service.

Disconnect and remove the remote cable or hydraulic hose from the fork or rear shock, if applicable. For additional information about RockShox remotes, user manuals are available at [www.sram.com/service](http://www.sram.com/service).

Clean the exterior of the product with mild soap and water to avoid contamination of internal sealing part surfaces.

## Service Procedures

The following procedures should be performed throughout service, unless otherwise specified.

Clean the part with RockShox Suspension Cleaner or isopropyl alcohol and a clean, lint-free shop towel. For hard to reach places (e.g. upper tube, lower leg), wrap a clean, lint-free shop towel around a non-metallic dowel to clean the inside.

Clean the sealing surface on the part and inspect it for scratches.

### **⚠ WARNING - CRASH HAZARD**

DO NOT use vinegar of any type to clean any part of a RockShox suspension product. Vinegar can cause permanent damage to parts which can, over time, result in product structural failure, serious injury, and possibly death.

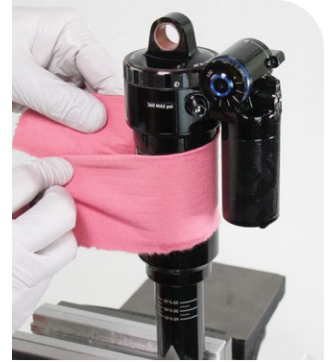

Replace the o-ring or seal with a new one from the service kit. Use your fingers or a pick to pierce and remove the old seal or o-ring.

Apply grease to the new seal or o-ring.

### **NOTICE**

Do not scratch any sealing surfaces when servicing the product. Scratches can cause leaks. Consult the RockShox Spare Parts Catalog to replace the damaged part.

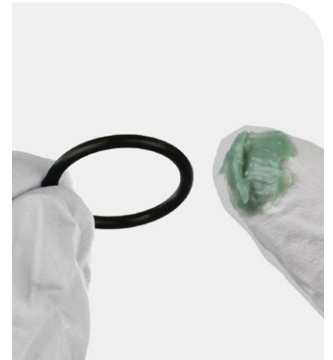

Use aluminum soft jaws when placing a part in a bench vise.

Tighten the part with a torque wrench to the torque value listed in the red bar. When using a crowfoot socket and torque wrench, install the crowfoot socket at 90 degrees to the torque wrench.

### **⚠ WARNING - CRASH HAZARD**

Parts must be tightened to the specified torque. Failure to do so can result in **SERIOUS INJURY OR DEATH.**

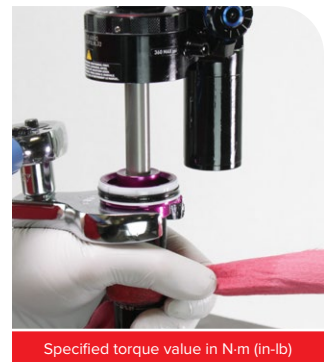

## Model Code Identification

Product model code and specification details can be identified with the serial number on the product. Model codes can be used to identify the product type, series name, model name, and product version associated with the production model year. Product details can be used to identify spare parts, service kit, and lubricant compatibility.

Model Code example: **RS-SDLX-ULT-C2**

**RS** = Product Type - **Rear Shock**

**SDLX** = Platform/Series - **Super Deluxe**

**ULT** = Model - **Ultimate**

**C2** = Version - (**C** - third generation, **2** - second iteration)

To identify the model code, locate the serial number on the product and enter it into the **Search by Model Name or Serial Number** field at [www.sram.com/service](http://www.sram.com/service).

## Warranty and Trademark

For SRAM Warranty information, visit: [www.sram.com/warranty](http://www.sram.com/warranty).

For SRAM Trademark information, visit: [www.sram.com/website-terms-of-use](http://www.sram.com/website-terms-of-use).

## Recommended Service Intervals

Regular service is required to keep your RockShox product working at peak performance. Follow this maintenance schedule and install the service parts included in each service kit that corresponds with the Service Hours Interval recommendation below. For spare part kit contents and details, refer to the *RockShox Spare Parts Catalog* at [www.sram.com/service](http://www.sram.com/service).

Service Hours Interval	Maintenance	Benefit
Every ride	Clean dirt from shock damper body and wiper seal	Extends wiper seal lifespan
		Minimizes damage to shock damper body
		Minimizes air can contamination
Every 50 Hours	Perform air can service	Reduces friction
		Restores small bump sensitivity
Every 200 Hours	Perform damper and spring service	Extends suspension lifespan
		Restores suspension performance

## Record Your Settings

Use the table below to record your shock settings to return your shock to its pre-service settings. Record your service date to track service intervals.

Service Hours Interval	Date of Service	Air Pressure	Rebound setting - Count the number of clicks while turning the rebound adjuster fully counterclockwise.	Compression setting - Count the number of clicks while turning the compression adjuster fully counterclockwise.	
				High Speed (HSC)	Low Speed (LSC)
50					
100					
150					
200					
400					

## Torque Values

Part	Tool	Torque
Air can to shaft eyelet assembly	13 mm crowfoot (standard eyelet)	10 N•m (90 in-lb)
	29 mm crowfoot (bearing eyelet)	
	54 mm crowfoot (trunnion mount)	
Bleed screw - damper body	T10 TORX bit socket	0.8 N•m (7 in-lb)
Bleed screw - internal floating piston (IFP)	T10 TORX bit socket	Tighten until IFP spins
Bolt (x2) - damper body bearing eyelet assembly to damper body	3 mm bit socket	6.2 N•m (55 in-lb)
Piston bolt to damper shaft	12 mm socket	6.2 N•m (55 in-lb)
Rear Shock Bearing Adapter	22 mm crowfoot	10 N•m (90 in-lb)
Sealhead / air piston to damper body	34 mm crowfoot	28 N•m (250 in-lb)
Set screw - Threshold Lever (Select RT)	1.5 mm bit socket	0.73 N•m (6.5 in-lb)
Set screw - Threshold Lever (Select+ RCT, Ultimate RC2T)	2 mm bit socket	1.13 N•m (10 in-lb)

## Parts

- 2023+ (Gen C) Super Deluxe Service Kit - 50 or 200 Hour
- Rear Shock Eyelet Bushing Kit (standard eyelets)
- Rear Shock Eyelet Bearing Kit (bearing eyelet) - for Rear Shock Damper Body Bearing Eyelet Mount Assembly
- Rear Shock Damper Body Bearing Eyelet Assembly (includes bearings)
- Rear Shock Bearing Adapter Upgrade Kit - 8x30 23mm OD (convert standard DU Bushings to Bearings on 8x30 frames) uses 22mm wrench - Deluxe, Super Deluxe B1+(2023+), SIDLuxe A1+(2021+)
- Upgrade Kit (optional) - Super Deluxe C2 Ultimate RC2T Reservoir
- Air Can Upgrade Kit - Linear XL (includes air can, volume spacers, seals, grease, oil, and decals) – Deluxe Gen C+/Super Deluxe Select/Select+/Ultimate Gen C+ (Does not fit FA) - (37.5-45 mm, 47.5-55 mm, 57.5-65 mm)

## Safety and Protection Supplies

- Apron
- Clean, lint-free shop towels
- Nitrile gloves
- Oil pan
- Safety glasses

## Lubricants and Fluids

- Maxima Extra 15w50 Suspension Oil or Maxima PLUSH Dynamic Suspension Lube Light
- Maxima PLUSH 7wt Suspension Oil
- RockShox Dynamic Seal Grease
- RockShox Suspension Cleaner or isopropyl alcohol

## RockShox Tools

- RockShox 1/2" x 1/2" Rear Shock Bushing Tool
- RockShox Air Valve Adapter Tool - Rear Shock
- RockShox IFP Height Tool V2 - Super Deluxe/Super Deluxe Coil (00.4318.041.002)
- RockShox Rear Shock DU Bushing Sizing Tool 1/2"x1/2" (for sizing bushings and installing hardware) - RockShox
- RockShox Rear Shock IFP Puller (00.4318.041.001)
- RockShox Rear Shock Vise Blocks 3-hole
- RockShox Shock Pump (350 psi max)
- RockShox Schrader Valve Tool
- RockShox x Abbey Tools - Trunnion Mount Crowfoot Tool

## Common Tools

- Adjustable open end wrench (54 mm)
- Bearing press tool: 22 mm (OD) x 10 mm (ID) (bearing eyelet only)
- Bearing punch: 1/8" / 3 mm (OD) - eyelet bearing removal
- Bench vise with soft jaws
- Crowfoot socket wrench: 22, 29, 34, 54 mm
- Digital Measurement Caliper
- Flat blade screwdriver
- Hammer / Mallet
- Hex bit sockets: 1.5, 2, 3 mm
- Hex wrenches: 1.5, 2, 3 mm
- Open end wrench: 13 (x2), 22, 29, 34, 54 mm
- Open end wrench 22 mm or adjustable open end wrench (for Rear Shock Bearing Adapter - 23 mm)
- Pick (metallic and non-metallic)
- Ruler or caliper (metric)
- Small diameter bearing punch (bearing eyelet only)
- Socket: 12 mm
- Socket wrench
- Rubber strap wrench (x2 - Linear XL air can)
- Torque wrench
- TORX bit socket: T10
- TORX wrench: T10

Use ONLY RockShox, SRAM, and Maxima suspension oils/fluids and grease, unless otherwise specified. Use of any other lubricants can damage seals and decrease performance.

## NOTICE

Use only 2023+ (Gen C) Super Deluxe spare parts and service kits with 2023+ (Gen C) Super Deluxe.

2018-2022 (Gen A-B) Super Deluxe spare parts and service kits are NOT compatible with 2023+ (Gen C) Super Deluxe.

## ⚠ WARNING

Before disassembly or service of any air system remove the air pressure from all air chambers and remove the air valve cores, unless otherwise instructed.

If your shock will not return to full extension, do not attempt to service or disassemble your shock. Attempting to service a shock that will not return to full extension can cause severe and/or fatal injuries.

## SAFETY INSTRUCTIONS

Always wear safety glasses and nitrile gloves when working with suspension grease and oil.

Place an oil pan on the floor underneath the area where you will be working on the shock.

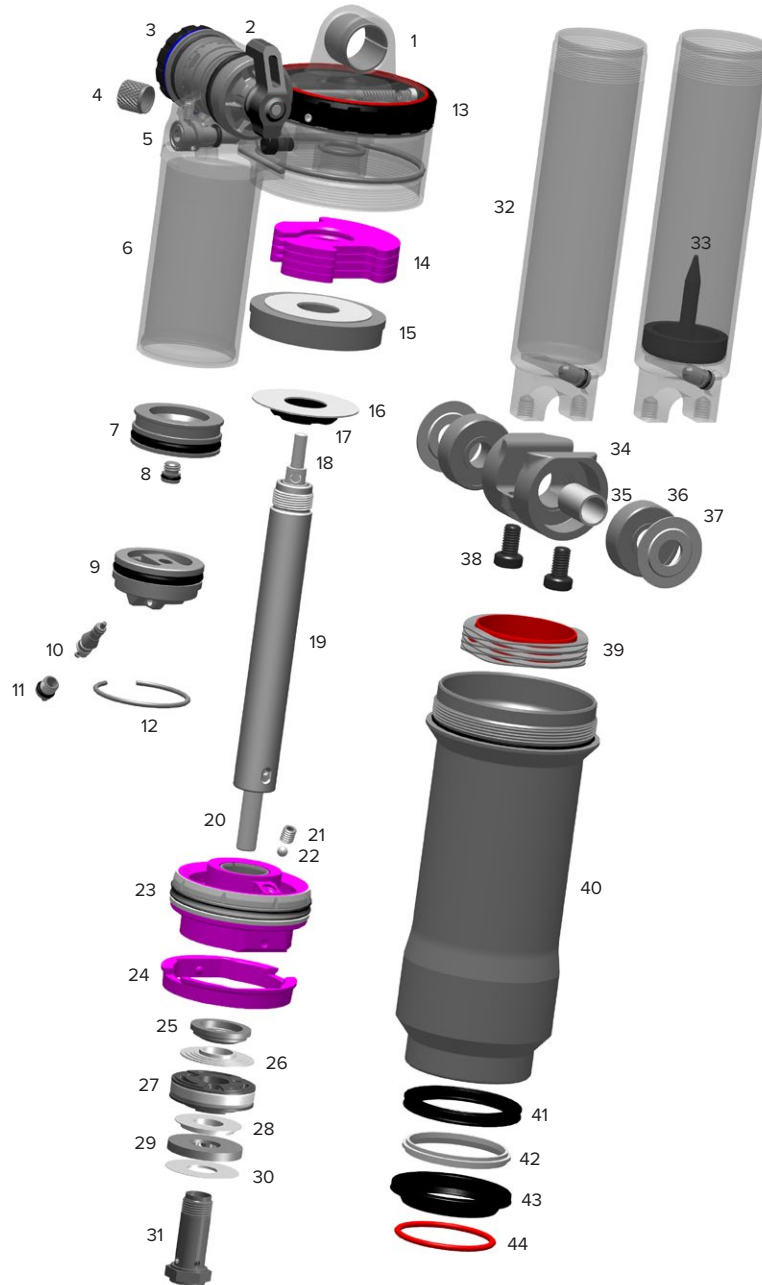

- |  |                             |                                  |
|--|-----------------------------|----------------------------------|
| 1. Standard eyelet / mount                 | 16. Washer                  | 31. Piston stud                  |
| 2. Lever - Threshold (Pedal)               | 17. Bumper                  | 32. Damper body                  |
| 3. Adjuster - Low Speed Compression (LSC)  | 18. Rebound needle          | 33. Needle - Hydraulic Bottomout |
| 4. Air valve cap                           | 19. Damper shaft            | 34. Bearing mount                |
| 5. Adjuster - High Speed Compression (HSC) | 20. Needle                  | 35. Bearing pin                  |
| 6. Reservoir can                           | 21. Bleed screw (sealhead)  | 36. Bearing (x2)                 |
| 7. Internal Floating Piston (IFP)          | 22. Nylon compression ball  | 37. Bearing cover (x2)           |
| 8. Bleed screw (IFP)                       | 23. Sealhead                | 38. Bolt - bearing mount (x2)    |
| 9. Cap - reservoir                         | 24. Negative volume reducer | 39. Counter Measure spring       |
| 10. Schrader valve - reservoir             | 25. Top out plate           | 40. Air can - Progressive        |
| 11. Air cap - IFP Schrader valve           | 26. Rebound shim stack      | 41. Quad ring seal               |
| 12. Retaining ring - IFP cap               | 27. Damper piston           | 42. Bushing                      |
| 13. Adjuster - Rebound                     | 28. Compression shim stack  | 43. Wiper seal                   |
| 14. Bottomless Tokens (0-4)                | 29. Rebound check plate     | 44. Sag o-ring                   |
| 15. Traver reducer (2.5, 5, 7.5 mm)        | 30. Check shim stack        |                                  |

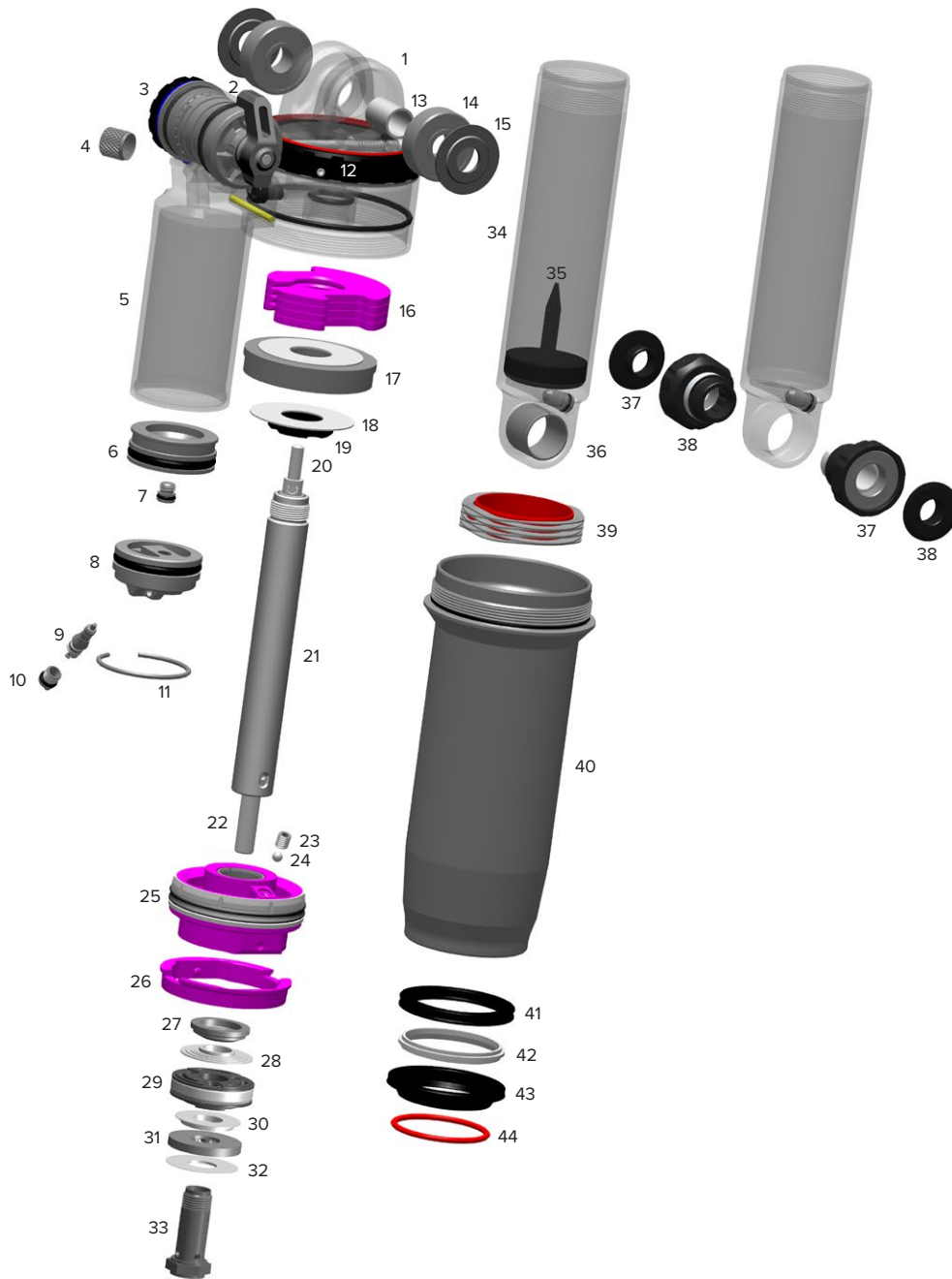

- |   |                                     |   |
|---|-------------------------------------|---|
| 1. Bearing mount eyelet / mount           | 16. Bottomless Tokens (0-4)         | 31. Rebound check plate   |
| 2. Lever - Threshold (Pedal)              | 17. Traver reducer (2.5, 5, 7.5 mm) | 32. Check shim stack  |
| 3. Adjuster - Low Speed Compression (LSC) | 18. Washer                          | 33. Piston stud   |
| 4. Air valve cap                          | 19. Bumper                          | 34. Damper body (standard eyelet)   |
| 5. Reservoir can                          | 20. Rebound needle                  | 35. Needle - Hydraulic Bottomout  |
| 6. Internal Floating Piston (IFP)         | 21. Damper shaft                    | 36. Standard eyelet / mount   |
| 7. Bleed screw (IFP)                      | 22. Needle                          | 37. Bearing Cover   |
| 8. Cap - reservoir                        | 23. Bleed screw (sealhead)          | 38. Standard Eyelet Bearing Adapter (23 mm)<br>- compatible with all Super Deluxe (Gen C)<br>models |
| 9. Schrader valve - reservoir             | 24. Nylon compression ball          | 39. Counter Measure spring  |
| 10. Air cap - IFP Schrader valve          | 25. Sealhead                        | 40. Air can - Linear  |
| 11. Retaining ring - IFP cap              | 26. Negative volume reducer         | 41. Quad ring seal  |
| 12. Adjuster - Rebound                    | 27. Top out plate                   | 42. Bushing   |
| 13. Bearing pin                           | 28. Rebound shim stack              | 43. Wiper seal  |
| 14. Bearing (x2)                          | 29. Damper piston                   | 44. Sag o-ring  |
| 15. Bearing cover (x2)                    | 30. Compression shim stack          |   |

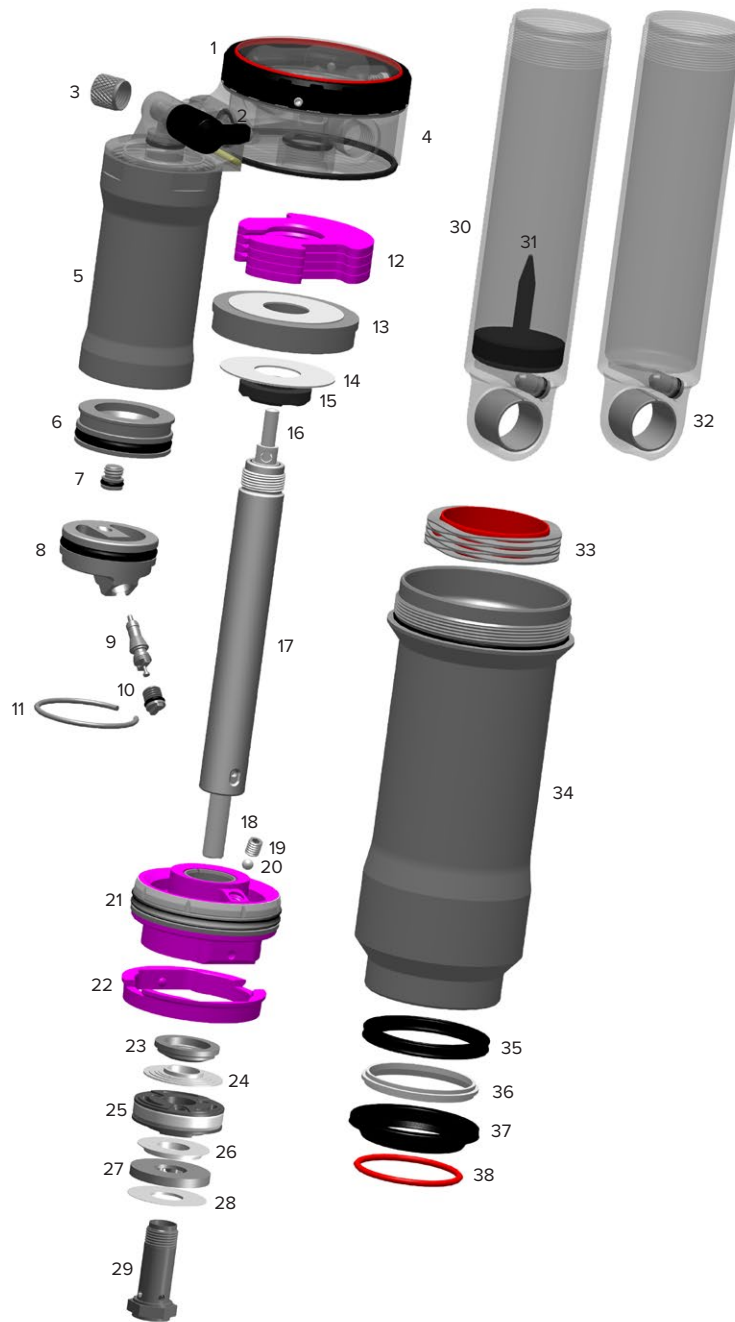

- |                                     |                             |                                  |
|-------------------------------------|-----------------------------|----------------------------------|
| 1. Adjuster - Rebound               | 16. Bearing pin             | 31. Needle - Hydraulic Bottomout |
| 2. Lever - Threshold (Pedal)        | 17. Rebound needle          | 32. Standard eyelet / mount      |
| 3. Air valve cap                    | 18. Damper shaft            | 33. Counter Measure spring       |
| 4. Trunnion eyelet/mount            | 19. Bleed screw (sealhead)  | 34. Air can - Progressive        |
| 5. Reservoir can                    | 20. Nylon compression ball  | 35. Quad ring seal               |
| 6. Internal Floating Piston (IFP)   | 21. Sealhead                | 36. Bushing                      |
| 7. Bleed screw (IFP)                | 22. Negative volume reducer | 37. Wiper seal                   |
| 8. Cap - reservoir                  | 23. Top out plate           | 38. Sag o-ring                   |
| 9. Schrader valve - reservoir       | 24. Compression shim stack  |                                  |
| 10. Air cap - IFP Schrader valve    | 25. Damper piston           |                                  |
| 11. Retaining ring - IFP cap        | 26. Rebound shim stack      |                                  |
| 12. Bottomless Tokens (0-4)         | 27. Rebound check plate     |                                  |
| 13. Traver reducer (2.5, 5, 7.5 mm) | 28. Check shim stack        |                                  |
| 14. Washer                          | 29. Piston stud             |                                  |
| 15. Bumper                          | 30. Damper body             |                                  |

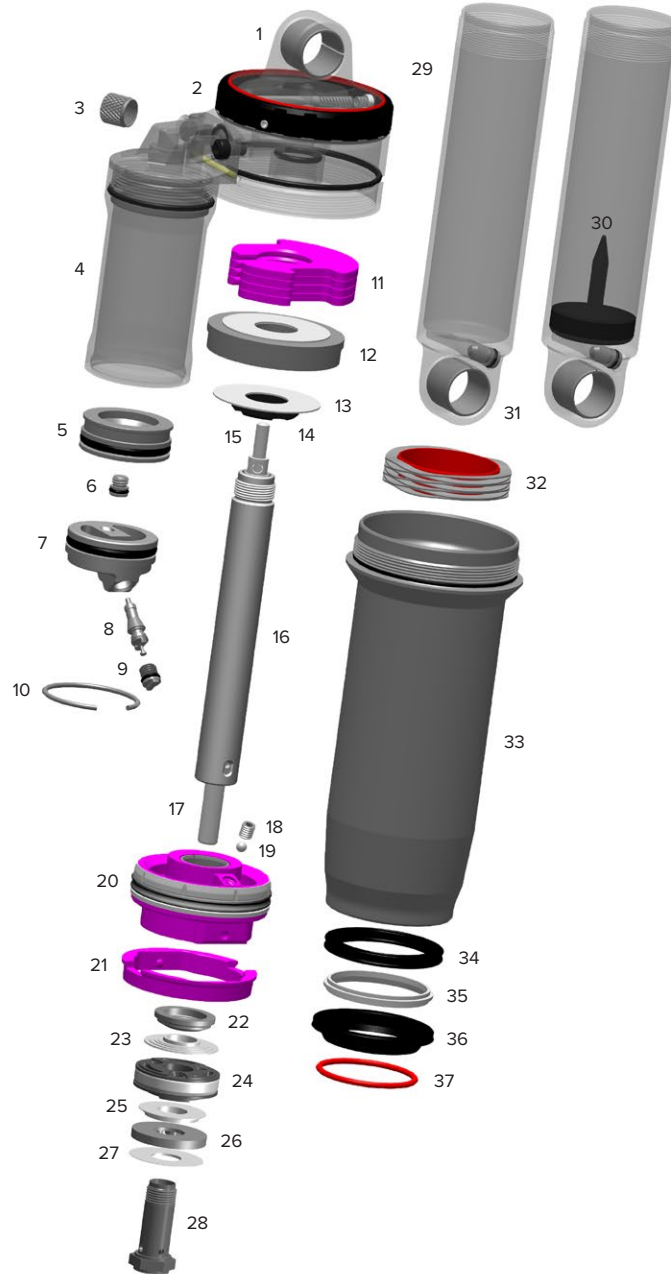

- |                                     |                                  |                                       |
|-------------------------------------|----------------------------------|---------------------------------------|
| 1. Standard eyelet/mount            | 16. Damper shaft                 | 31. Bearing Adapter (standard eyelet) |
| 2. Adjuster - Rebound               | 17. Bleed screw (sealhead)       | 32. Counter Measure spring            |
| 3. Air valve cap                    | 18. Nylon compression ball       | 33. Air can - Linear                  |
| 4. Reservoir can                    | 19. Sealhead                     | 34. Quad ring seal                    |
| 5. Internal Floating Piston (IFP)   | 20. Negative volume reducer      | 35. Bushing                           |
| 6. Bleed screw (IFP)                | 21. Top out plate                | 36. Wiper seal                        |
| 7. Cap - reservoir                  | 22. Rebound shim stack           | 37. Sag o-ring                        |
| 8. Schrader valve - reservoir       | 23. Damper piston                |                                       |
| 9. Air cap - IFP Schrader valve     | 24. Compression shim stack       |                                       |
| 10. Retaining ring - IFP cap        | 25. Rebound check plate          |                                       |
| 11. Bottomless Tokens (0-4)         | 26. Check shim stack             |                                       |
| 12. Traver reducer (2.5, 5, 7.5 mm) | 27. Piston stud                  |                                       |
| 13. Washer                          | 28. Damper body                  |                                       |
| 14. Bumper                          | 29. Standard eyelet / mount      |                                       |
| 15. Rebound needle                  | 30. Needle - Hydraulic Bottomout |                                       |

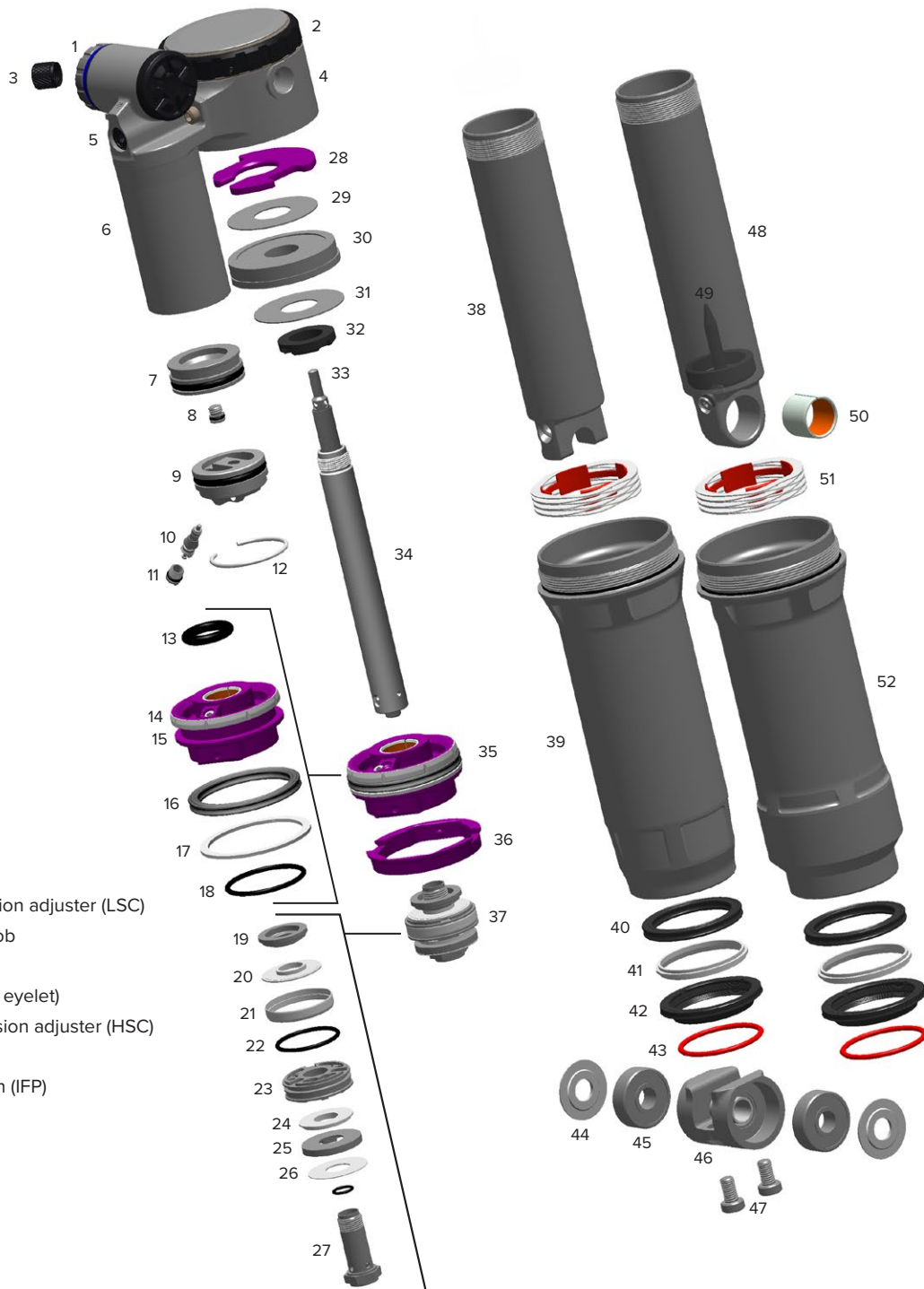

- 1. Low speed compression adjuster (LSC)
- 2. Rebound adjuster knob
- 3. Air cap
- 4. Shaft eyelet (trunnion eyelet)
- 5. High speed compression adjuster (HSC)
- 6. Reservoir
- 7. Internal floating piston (IFP)
- 8. Bleed screw (IFP)
- 9. IFP reservoir cap
- 10. Schrader valve
- 11. Schrader valve cap
- 12. Retaining ring
- 13. Inner o-ring
- 14. Backup ring (fixed)
- 15. Sealhead / air piston
- 16. Quad ring
- 17. Backup ring
- 18. Inner underside o-ring
- 19. Topout plate
- 20. Compression shims
- 21. Glide ring
- 22. O-ring
- 23. Damper piston
- 24. Rebound shims
- 25. Check plate
- 26. Check shims
- 27. Piston bolt

- 28. Bottomless Token(s)
- 29. Washer
- 30. Travel reducer (2.5 mm, 5 mm, 7.5 mm)
- 31. Washer
- 32. Bottomout bumper
- 33. Rebound needle
- 34. Damper shaft
- 35. Sealhead / air piston
- 36. Negative volume Token
- 37. Damper piston
- 38. Damper body (bearing eyelet)
- 39. Air can (linear)
- 40. Quad ring seal
- 41. Bushing

- 42. Wiper seal
- 43. Sag o-ring
- 44. Bearing dust cover (x2)
- 45. Bearing (x2)
- 46. Bearing housing
- 47. Bearing housing bolts (x2)
- 48. Damper body (standard eyelet)
- 49. Hydraulic bottomout needle (not removable)
- 50. Eyelet bushing
- 51. Counter Measure
- 52. Air can (progressive)

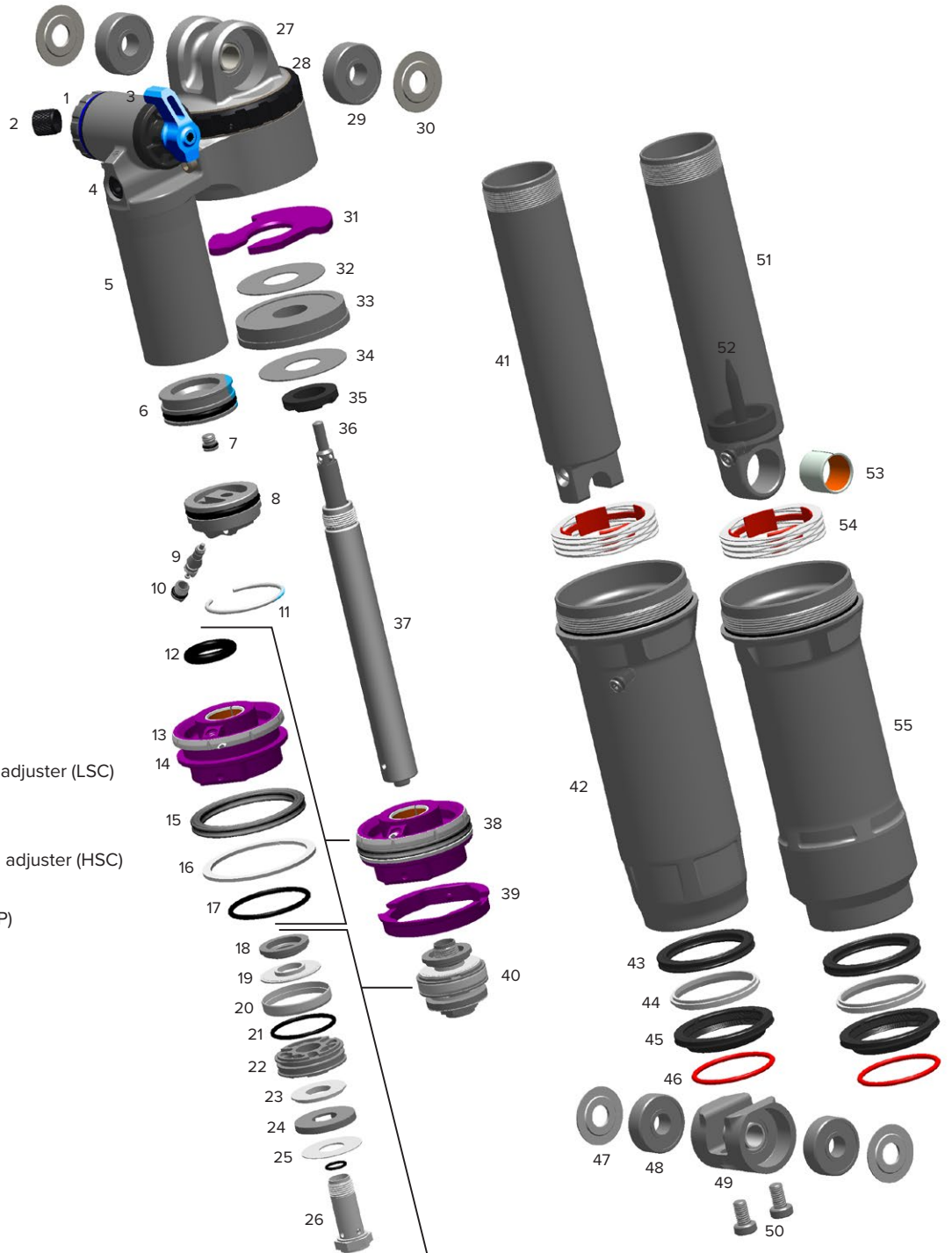

- 1. Low Speed Compression adjuster (LSC)
- 2. Air cap
- 3. Threshold lever (pedal)
- 4. High Speed Compression adjuster (HSC)
- 5. Reservoir
- 6. Internal floating piston (IFP)
- 7. Bleed screw (IFP)
- 8. IFP reservoir cap
- 9. Schrader valve
- 10. Schrader valve cap
- 11. Retaining ring
- 12. Inner o-ring
- 13. Backup ring (fixed)
- 14. Sealhead / air piston
- 15. Quad ring seal
- 16. Backup ring
- 17. Inner underside o-ring
- 18. Topout plate
- 19. Compression shims
- 20. Glide ring
- 21. O-ring
- 22. Damper piston
- 23. Rebound shims
- 24. Check plate
- 25. Check shims
- 26. Piston bolt
- 27. Shaft eyelet (bearing eyelet)
- 28. Rebound adjuster knob
- 29. Eyelet bearing (x2)
- 30. Bearing dust cover (x2)

- 31. Bottomless Token(s)
- 32. Washer
- 33. Travel reducer (2.5 mm, 5 mm, 7.5 mm)
- 34. Washer
- 35. Bottomout bumper
- 36. Rebound needle
- 37. Damper shaft
- 38. Sealhead / air piston
- 39. Negative volume Token
- 40. Damper piston
- 41. Damper body (bearing eyelet)
- 42. Air can (linear)
- 43. Quad ring seal

- 44. Bushing
- 45. Wiper seal
- 46. Sag o-ring
- 47. Bearing dust cover (x2)
- 48. Bearing (x2)
- 49. Bearing housing
- 50. Bearing housing bolts (x2)
- 51. Damper body (standard eyelet)
- 52. Hydraulic bottomout needle (not removable)
- 53. Eyelet bushing
- 54. Counter Measure
- 55. Air can (progressive)

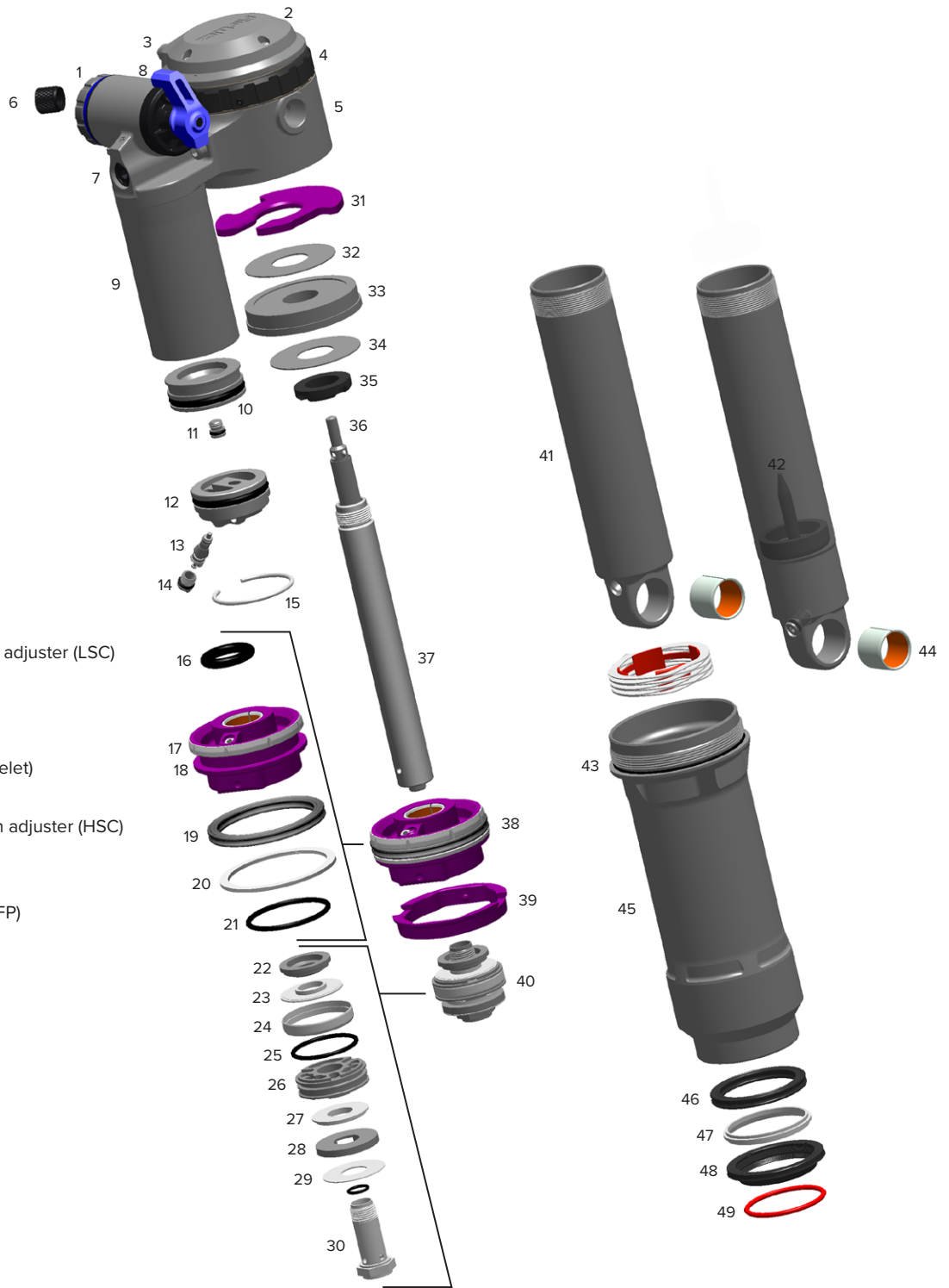

- 1. Low speed compression adjuster (LSC)
- 2. \*AirWiz cover
- 3. AirWiz button
- 4. Rebound adjuster knob
- 5. Shaft eyelet (trunnion eyelet)
- 6. Air cap
- 7. High speed compression adjuster (HSC)
- 8. Threshold lever (pedal)
- 9. Reservoir
- 10. Internal floating piston (IFP)
- 11. Bleed screw (IFP)
- 12. IFP reservoir cap
- 13. Schrader valve
- 14. Schrader valve cap
- 15. Retaining ring
- 16. Inner o-ring
- 17. Backup ring (fixed)
- 18. Sealhead / air piston
- 19. Quad ring seal
- 20. Backup ring
- 21. Inner underside o-ring
- 22. Topout plate
- 23. Compression shims
- 24. Glide ring
- 25. O-ring
- 26. Damper piston
- 27. Rebound shims
- 28. Check plate
- 29. Check shims
- 30. Piston bolt
- 31. Bottomless Token(s)
- 32. Washer

- 33. Travel reducer (2.5 mm, 5 mm, 7.5 mm)
- 34. Washer
- 35. Bottomout bumper
- 36. Rebound needle
- 37. Damper shaft
- 38. Sealhead / air piston
- 39. Negative volume Token
- 40. Damper piston
- 41. Damper body (standard eyelet)

- 42. Hydraulic bottomout needle (not removable)
- 43. Counter Measure
- 44. Eyelet bushing
- 45. Air can (progressive)
- 46. Quad ring seal
- 47. Bushing
- 48. Wiper seal
- 49. Sag o-ring

\*Do not remove the AirWiz electronics cover during service.  
Removal during service can result in permanent damage to the internal electronic components.

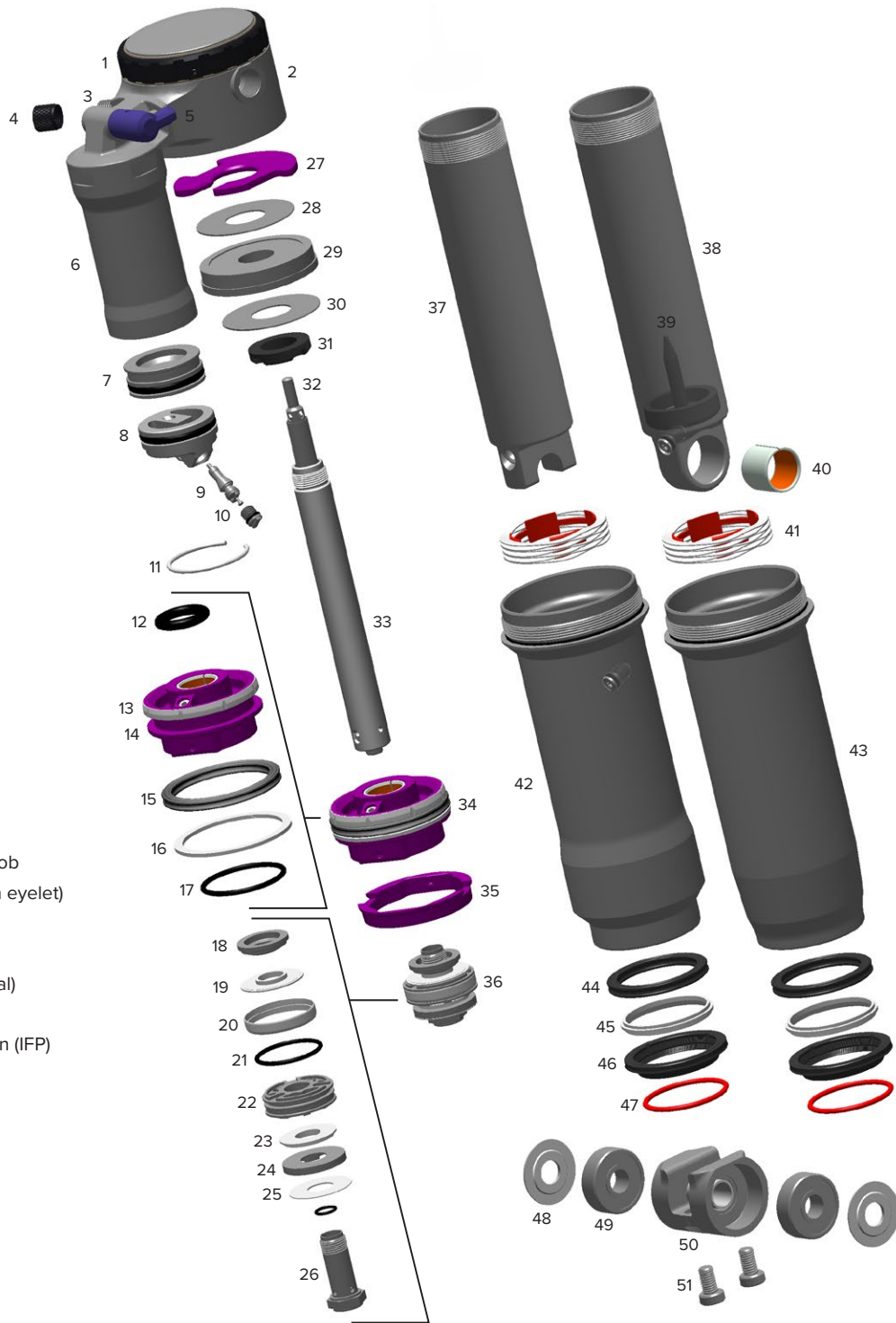

- 1. Rebound adjuster knob
- 2. Shaft eyelet (trunnion eyelet)
- 3. Air valve
- 4. Air cap
- 5. Threshold lever (pedal)
- 6. Reservoir
- 7. Internal floating piston (IFP)
- 8. IFP reservoir cap
- 9. Schrader valve
- 10. Schrader valve cap
- 11. Retaining ring
- 12. Inner o-ring
- 13. Backup ring (fixed)
- 14. Sealhead / air piston
- 15. Quad ring seal
- 16. Backup ring
- 17. Inner underside o-ring
- 18. Topout plate
- 19. Compression shims
- 20. Glide ring
- 21. O-ring
- 22. Damper piston
- 23. Rebound shims
- 24. Check plate
- 25. Check shims
- 26. Piston bolt
- 27. Bottomless Token(s)
- 28. Washer

- 29. Travel reducer (2.5 mm, 5 mm, 7.5 mm)
- 30. Washer
- 31. Bottomout bumper
- 32. Rebound needle
- 33. Damper shaft
- 34. Sealhead / air piston
- 35. Negative volume Token
- 36. Damper piston
- 37. Damper body (bearing eyelet)
- 38. Damper body (standard eyelet)
- 39. Hydraulic bottomout needle (not removable)

- 40. Bushing
- 41. Counter Measure
- 42. Air can (progressive)
- 43. Air can (linear)
- 44. Quad ring seal
- 45. Bushing
- 46. Wiper seal
- 47. Sag o-ring
- 48. Bearing dust cover (x2)
- 49. Bearing (x2)
- 50. Bearing housing
- 51. Bearing housing bolts (x2)

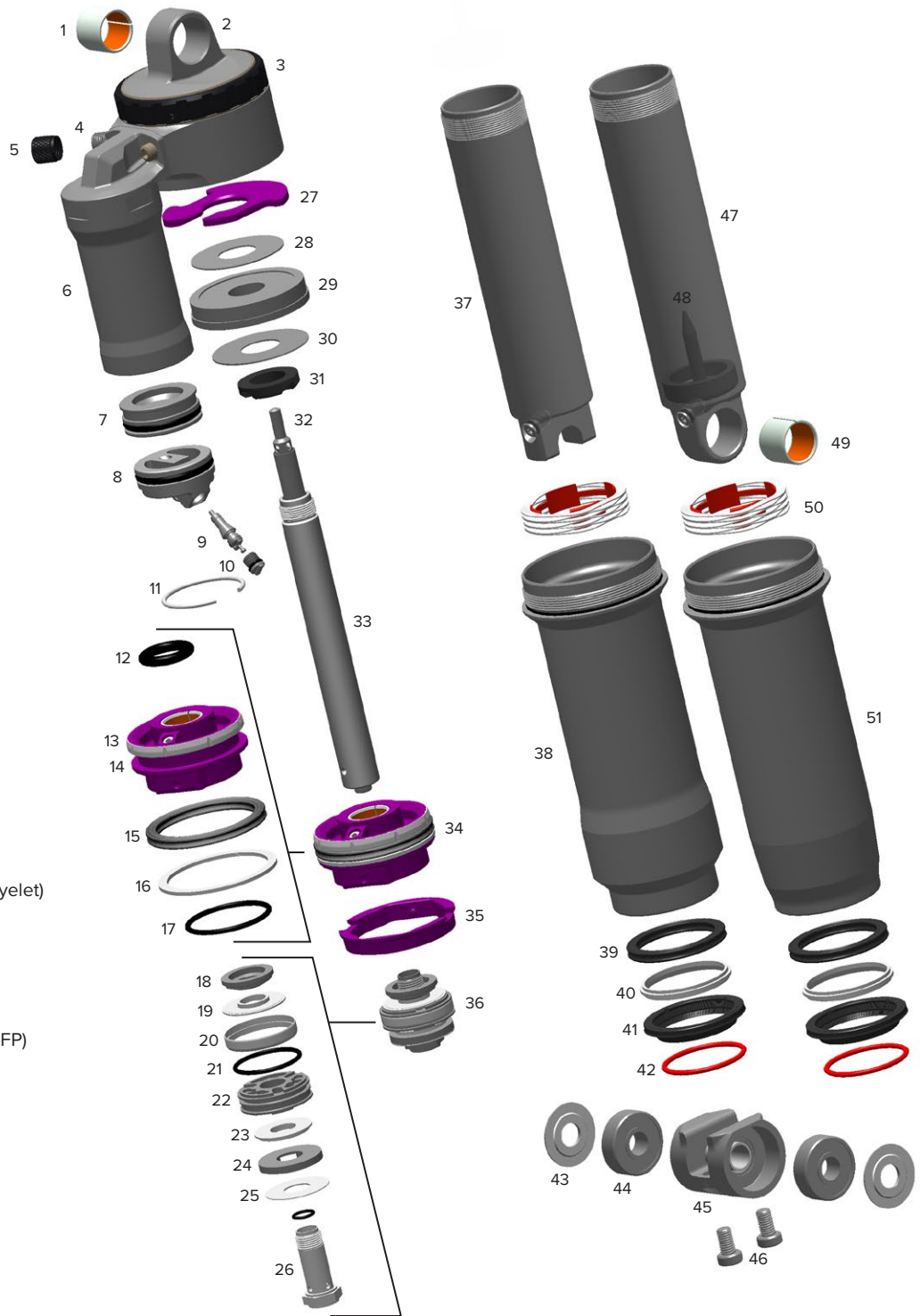

- 1. Eyelet bushing
- 2. Shaft eyelet (standard eyelet)
- 3. Rebound adjuster knob
- 4. Air valve
- 5. Air cap
- 6. Reservoir
- 7. Internal floating piston (IFP)
- 8. IFP reservoir cap
- 9. Schrader valve
- 10. Schrader valve cap
- 11. Retaining ring
- 12. Inner o-ring
- 13. Backup ring (fixed)
- 14. Sealhead / air piston
- 15. Quad ring seal
- 16. Backup ring
- 17. Inner underside o-ring
- 18. Topout plate
- 19. Compression shims
- 20. Glide ring
- 21. O-ring
- 22. Damper piston
- 23. Rebound shims
- 24. Check plate
- 25. Check shims
- 26. Piston bolt
- 27. Bottomless Token(s)
- 28. Washer

- 29. Travel reducer (2.5 mm, 5 mm, 7.5 mm)
- 30. Washer
- 31. Bottomout bumper
- 32. Rebound needle
- 33. Damper shaft
- 34. Sealhead / air piston
- 35. Negative volume Token
- 36. Damper piston
- 37. Damper body (bearing eyelet)
- 38. Air can (progressive)
- 39. Quad ring seal
- 40. Bushing

- 41. Wiper seal
- 42. Sag o-ring
- 43. Bearing dust cover (x2)
- 44. Bearing (x2)
- 45. Bearing housing
- 46. Bearing housing bolts (x2)
- 47. Damper body (standard eyelet)
- 48. Hydraulic bottomout needle (not removable)
- 49. Eyelet bushing
- 50. Counter Measure
- 51. Air can (linear)

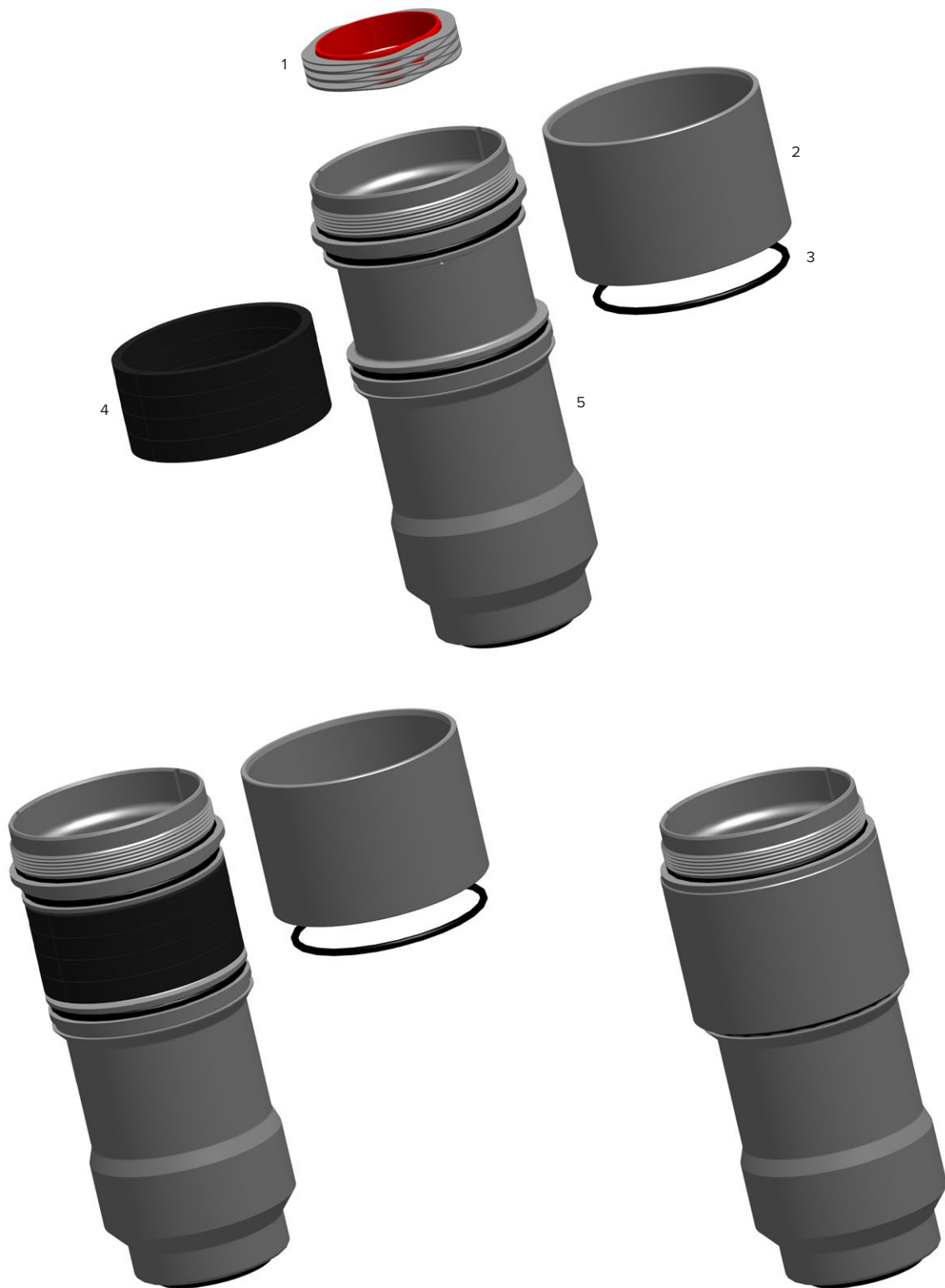

1. Counter Measure
2. Air can sleeve
3. Air can sleeve o-ring
4. Bottomless Tokens (Linear XL)
5. Air can (37.5-45 mm, 47.5-55 mm, or 57.5-65 mm)

\*The Linear XL air can (upgrade) is NOT compatible with Super Deluxe Ultimate Flight Attendant.

## Shock Eyelet Service - Standard Eyelet

Prior to servicing the rear shock, remove it from the bicycle frame according to the bicycle manufacturer's instructions. Once the shock is removed from the bicycle, remove the mounting hardware before performing any service.

**Bearing Adapter (optional):** Follow the Mounting Hardware Removal and Eyelet Bushing Removal procedures if a RockShox Bearing Adapter (23 mm) will be installed into a damper shaft standard eyelet or damper body standard eyelet. If installed, remove the standard eyelet mounting hardware and standard eyelet bushing only. Procedures are the same for damper shaft and damper body standard eyelets.

**Super Deluxe Ultimate RCT2 AirWiz:** Do not clamp the AirWiz electronics cover in a vise.

## Mounting Hardware Removal (Service and Optional Bearing Adapter Installation)

Deluxe is pictured. Procedures are the same for Super Deluxe (Gen C).

### NOTICE

To prevent damage to the shock, clamp the shock with vise soft jaws in a vise. Do NOT clamp any part of the shock against steel vise jaws. Before clamping the shock in place in the vise with vise soft jaws, confirm no part of the shock interferes with, or could be damaged by, the vise or the vise soft jaws.

Some mounting hardware is easily removed using only your fingers. Try to remove the end spacers with your fingernail or small screwdriver, then push the bushing pin out of the bushing. If this works, continue to the next section.

If you are unable to remove the mounting hardware using your fingers, use the RockShox rear shock bushing removal/installation tool.

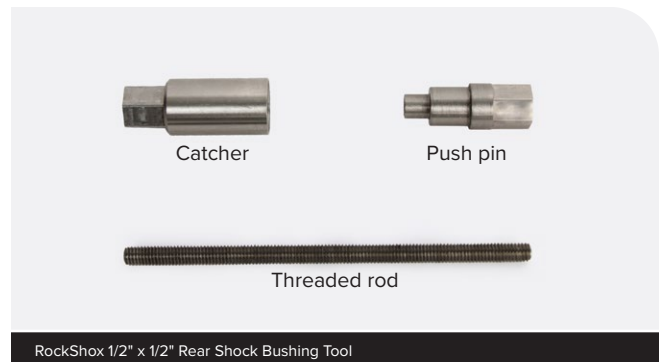

- 1 Thread the small end of the push pin (A) onto the threaded rod (B) until the rod protrudes from the hex-shaped end of the push pin.

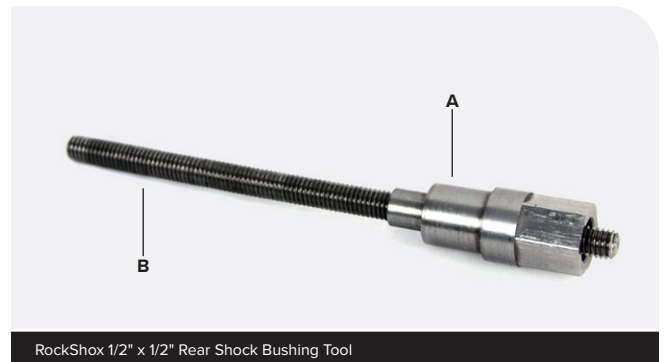

- 2** Insert the threaded rod (A) through the eyelet until the push pin (B) rests against the bushing pin.

Thread the large, open end of the catcher (C) along the rod until it rests on the end spacer.



- 3** Clamp the catcher in a vise or hold it secure with a 13 mm open end or adjustable wrench.

**NOTICE**

Do not damage the shock with the wrenches.

Use a second 13 mm wrench to thread the push pin into the bushing pin and eyelet until it stops against the end spacer, or when spacer is free from the pin.

Unthread the catcher and push pin from the threaded rod to remove the end spacer and the bushing pivot pin.



13 mm

13 mm



- 4** If the bushing pin does not remove easily, reinsert the threaded rod and push pin through the eyelet shaft.

Thread the large, open end of the catcher along the rod until it rests against the shaft end spacer.

Use a 13 mm wrench to thread the push pin along the rod until it pushes the pin completely out of the eyelet and stops against the eyelet.

**NOTICE**

Do not damage the shock with the wrenches.



13 mm

13 mm

**5** Unthread the catcher from the threaded rod.

Remove the end spacer and bushing pin from the tool. Remove the spacer from the bushing pin.

**Damper Body with Standard Eyelet:** Repeat steps 2-4 for the damper eyelet.

**Eyelet Service:** Clean the mounting hardware and set aside. Install the mounting hardware after shock service is complete.

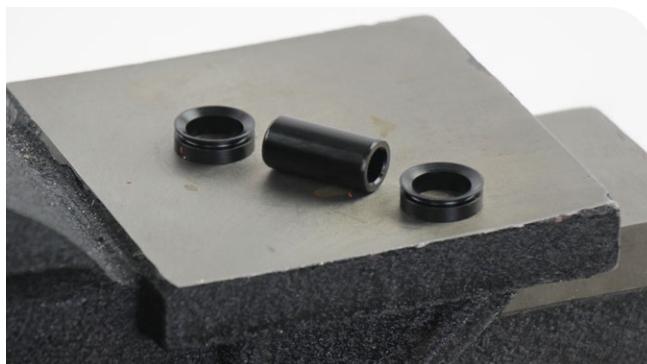

## Eyelet Bushing Removal

To remove the eyelet bushing, use the RockShox 1/2" x 1/2" Rear Shock Bushing Tool.

**Bearing Adapter (optional):** Remove the eyelet bushing from the eyelet that a RockShox Bearing Adapter will be installed into.

- 1 Insert the threaded rod (A) through the eyelet until the base of the push pin (B) rests against the bushing.

Thread the large, open end of the catcher (C) onto the rod until it rests on the eyelet.

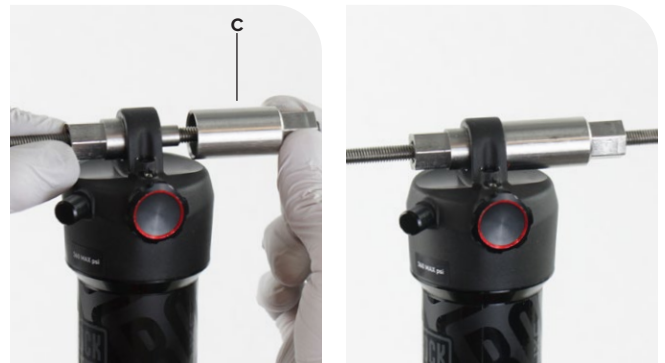
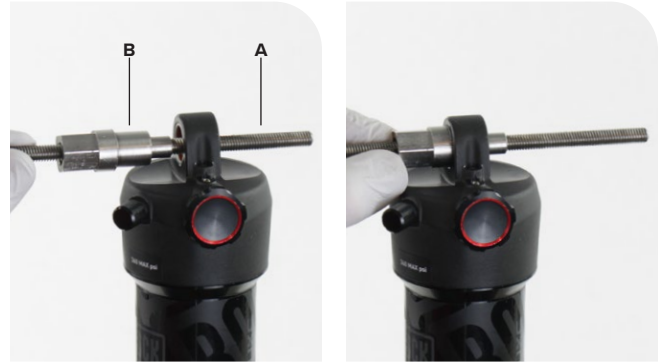

- 2 Clamp the catcher in a vise or hold it secure with a 13 mm open end or adjustable wrench.

Use a second 13 mm wrench to thread the push pin along the rod until the push pin pushes the eyelet bushing out of the eyelet.

### NOTICE

Do not damage the shock with the wrenches.

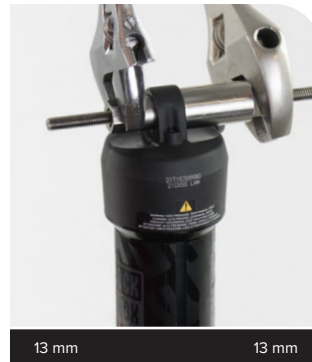

- 3 Unthread the catcher from the threaded rod. Remove the tool from the eyelet and discard the bushing.

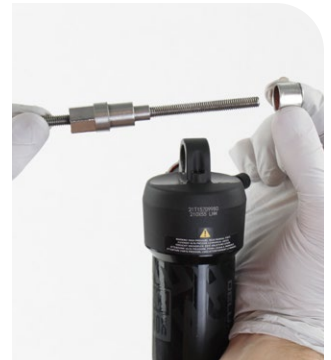

- 4 Clean the eyelet.  
Repeat steps 1-3 for the other eyelet (if applicable).



**Optional Upgrade (Bearing Mount Frame Only):** Standard Eyelet to Bearing Adapter - Proceed to [Standard Eyelet to Bearing Adapter Installation](#).

## Eyelet Bushing Installation

**Bearing Adapter Installation:** Do not install a new bushing into the standard eyelet (shaft eyelet and/or damper body eyelet) if a Bearing Adapter will be installed.

- 1 Apply a light layer of grease to the outside of the new bushing.



- 2 Position the shaft eyelet and eyelet bushing between the soft jaws of a vise. Slowly turn the vise handle to begin pressing the eyelet bushing into the shaft eyelet.

**Check the alignment of the bushing as it enters the eyelet. If the bushing starts to enter the eyelet at an angle, remove the bushing from the eyelet, regrease the bushing, and repeat this step until the bushing enters the eyelet straight.**

Continue to press the eyelet bushing until it is seated in the shaft eyelet.

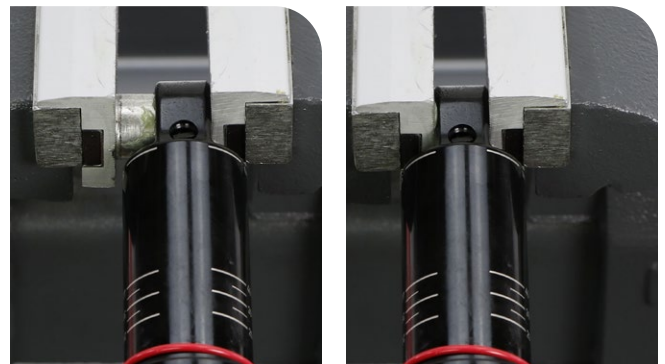

## Eyelet Bushing Sizing

A new standard eyelet bushing can be sized before the mount hardware pin is installed to ensure optimal fit and function.

### NOTICE

To prevent damage to the shock, clamp the shock with vise soft jaws in a vise. Do NOT clamp any part of the shock against steel vise jaws. Before clamping the shock in place in the vise with vise soft jaws, confirm no part of the shock interferes with, or could be damaged by, the vise or the vise soft jaws.

- 1 Insert the Bushing Sizer Pin into the eyelet bushing.

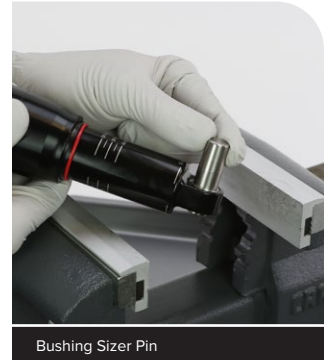

- 2 On the opposite side of the eyelet, position and hold the Bushing Sizer Pin Catcher against the eyelet.

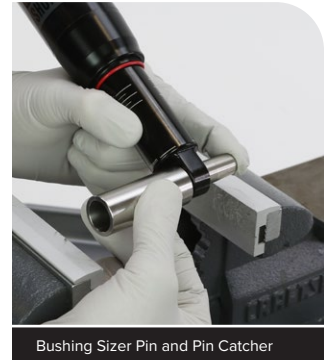

- 3 Clamp the Bushing Sizer Pin and Pin Catcher in the vise.



- 4 Hold the shock and Bushing Sizer steady and slowly close the vise to drive the Bushing Sizer Pin through the bushing and into the Pin Catcher.

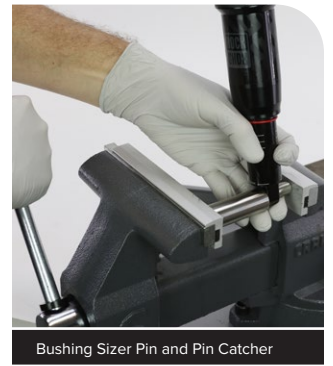

- 5 When the center of the Bushing Sizer Pin clears the bushing, the shock will no longer be supported by the vise. Hold the shock and Bushing Sizer Pin Catcher throughout the sizing procedure.

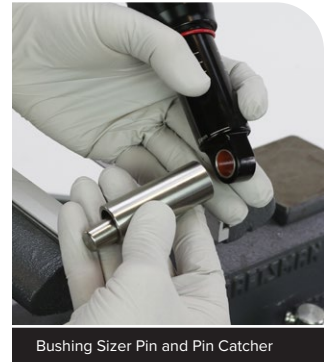

- 6 To complete the full eyelet bushing sizing procedure, repeat this procedure by pressing the Bushing Sizer Pin through the bushing again in the opposite side/direction.

**Optional:** If only standard eyelet mounting hardware is being installed, and shock service will NOT be performed, proceed to [Mounting Hardware Installation - Standard Eyelet](#).

## Shock Eyelet Service - Bearing Adapter (23 mm)

If installed, the RockShox Rear Shock Bearing Adapter must be removed before service.

### NOTICE

A Super Deluxe (Gen C) with a standard eyelet (damper body eyelet and/or shaft eyelet) is compatible with the 23 mm RockShox Rear Shock Bearing Adapter only. To avoid permanent damage to a Super Deluxe (Gen C) rear shock, do NOT install a 26 mm RockShox Rear Shock Bearing Adapter into the damper body and/or damper shaft standard eyelet.

### Bearing Adapter Removal

Deluxe is pictured. Procedures are the same for Super Deluxe (Gen C) unless otherwise pictured and/or described.

- 1 Clamp one side of the bearing adapter into a vise with soft jaws.

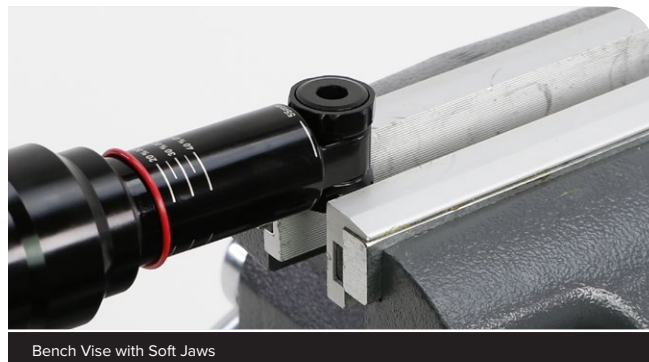

- 2 Unthread and remove one bearing adapter.

### NOTICE

Do NOT use a standard 22 mm socket to remove the RockShox Rear Shock Bearing Adapter. A standard socket may not be compatible. Use ONLY an open end wrench or adjustable wrench.

Do not damage the shock during bearing adapter removal and/or installation.

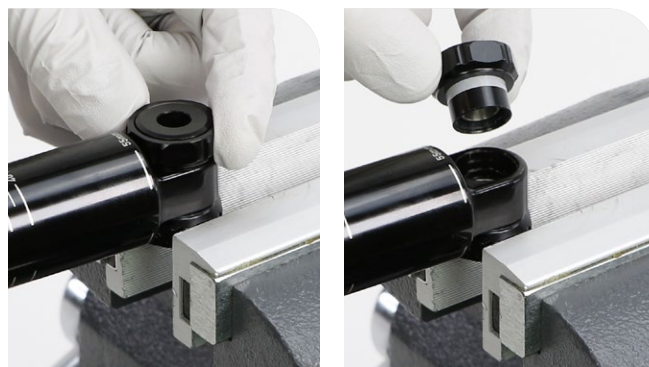
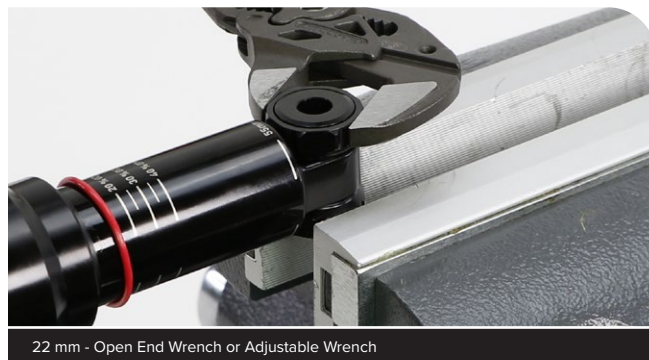

- 3** Pull the shock upward to remove the remaining bearing adapter.  
Remove the remaining bearing adapter from the vise.

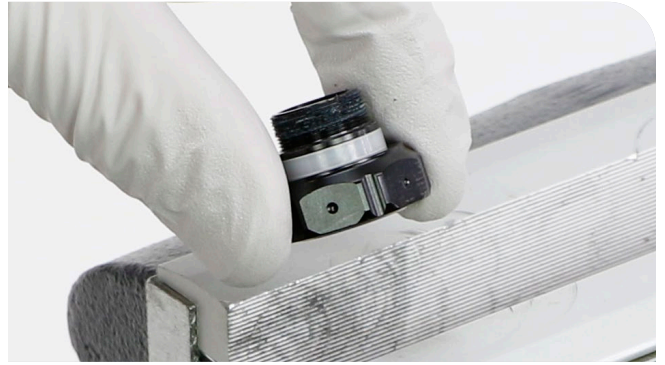
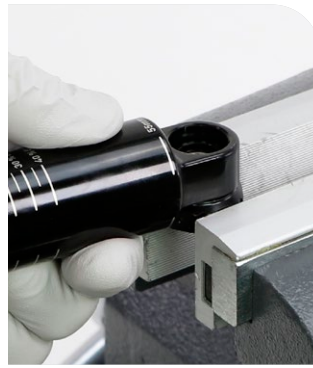

- 4** Remove the bearing covers from the bearing adapters.  
Clean the shock eyelet and both bearing adapters.

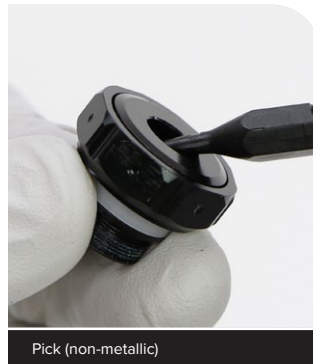

Pick (non-metallic)



# Shock Eyelet Service - Bearing Eyelet Mount

Replace the bearings if they are not spinning freely, or if they are making a creaking noise.

**Super Deluxe Ultimate RCT2 AirWiz:** Do not clamp the AirWiz electronics cover in a vise.

## Bearing Removal

Deluxe is pictured. Procedures are the same for Super Deluxe (Gen C).

### NOTICE

To prevent damage to the shock, clamp the shock with vise soft jaws in a vise. Do NOT clamp any part of the shock against steel vise jaws. Before clamping the shock in place in the vise with vise soft jaws, confirm no part of the shock interferes with, or could be damaged by, the vise or the vise soft jaws.

**1** Remove the dust covers.



**2 Damper Body Eyelet:** Clamp the eyelet securely in aluminum or plastic vise blocks. Position the eyelet securely on a flat surface.

**Shaft Eyelet:** Position the eyelet securely on a flat surface. To prevent damage to the air valve, remove the bearing on the side opposite of the air valve first.

Position the punch through one bearing and against the back of the opposite bearing. Press the end down against the outside bearing to secure it.

Tap the bearing out with two to three taps, then rotate to a new position around the bearing. Repeat until the bearing is pushed out evenly on all sides.



Hammer / Mallet

Bearing punch 1/8" / 3 mm (OD)

### NOTICE

Do not damage the shock when tapping out the bearing.

The center spacer will also be removed.

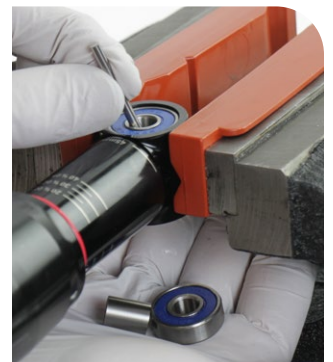
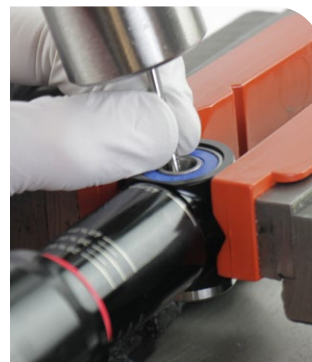

**3** Turn the shock over and repeat the bearing removal process.

**NOTICE**

Do not damage the shock when tapping out the bearing.

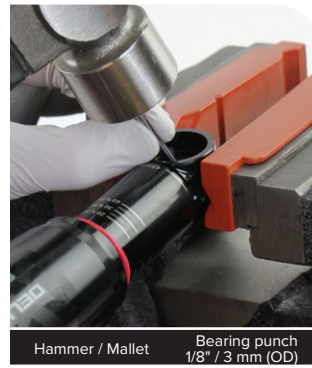

**4** Clean the bearing bores.



## Bearing Installation

- 1 Install a new bearing into one bearing bore, then clamp the eyelet and bearing into a vise with soft jaws. Press the bearing into the bearing bore until it is flush with the eyelet.



**2** Loosen the vise, and align the bearing press tool centered on the bearing, then slowly tighten the vise. Check and confirm the bearing press tool is centered and is not overlapping the bearing edge.

Press the bearing into the bearing bore until it stops.

Remove the shock and bearing press tool from the vise.

**NOTICE**

Do not overtighten the bearing. Overtightening can damage the bearing and cause it to malfunction.

To prevent damage to the bearing, make sure that the bearing press tool contacts both the inner and outer races of the bearing.



22 mm (OD) x 10 mm (ID)  
Bearing Press Tool

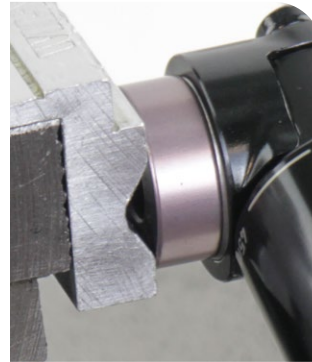

**3** Insert a new spacer into the eyelet, then install a new bearing into the other bearing bore.

Clamp the eyelet and bearing into a vise with soft jaws, then press the bearing into the bearing bore until it is flush with the eyelet.

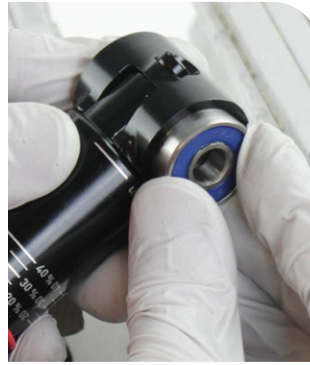

- 4** Loosen the vise, and align the bearing press tool centered on the bearing, then slowly tighten the vise. Check and confirm the bearing press tool is centered and is not overlapping the bearing edge.

Press the bearing into the bearing bore until it stops.

Remove the shock and bearing press tool from the vise.

### NOTICE

Do not overtighten the bearing. Overtightening can damage the bearing and cause it to malfunction.

To prevent damage to the bearing, make sure that the bearing press tool contacts both the inner and outer races of the bearing.

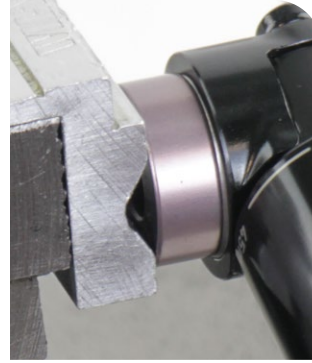

- 5** Remove the shock from the vise. The bearings should sit approximately 1 mm below the outer edge of the bearing bore.

Leave the dust covers off during shock service.

### NOTICE

To avoid permanent damage to the dust covers, do not clamp the eyelet in a vise with the bearing dust covers installed.

Reinstall the dust covers before installing the shock on the bicycle.



## Bearing Eyelet Mount - Replacement

- 1 Remove the bearing dust covers.



- 2 Remove the bearing eyelet mount bolts and remove the bearing eyelet mount assembly.



- 3 Install the new bearing eyelet mount assembly and bolts onto the shock.

Tighten the bolts.

### **⚠ WARNING - CRASH HAZARD**

Parts must be tightened to the specified torque. Failure to do so can result in SERIOUS INJURY OR DEATH.

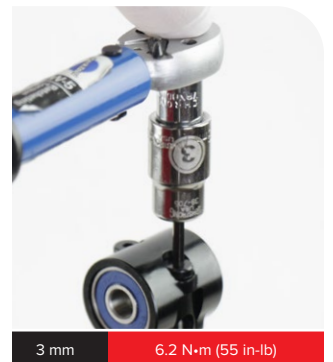

## Super Deluxe Service

Prior to servicing the rear shock, remove it from the bicycle frame according to the bicycle manufacturer's instructions. Remove the mounting hardware and the damper body bearing eyelet assembly before performing any service.

**Super Deluxe Ultimate RC2T AirWiz:** Super Deluxe Ultimate RC2T AirWiz is not pictured. All procedures are the same for Super Deluxe Ultimate RC2T and Super Deluxe Ultimate RC2T AirWiz unless otherwise described and/or pictured.

Do not remove the AirWiz electronics cover during service. Removal during service can result in permanent damage to the internal electronic components. Do not clamp the AirWiz electronics cover in a vise.

### NOTICE

Use only 2023+ (Gen C) Super Deluxe spare parts and service kits with 2023+ (Gen C) Super Deluxe.

2018-2022 (Gen A-B) Super Deluxe spare parts and service kits are NOT compatible with 2023+ (Gen C) Super Deluxe.

### ⚠ WARNING

Before disassembly or service of any air system remove the air pressure from all air chambers and remove the air valve cores, unless otherwise instructed.

If your shock will not return to full extension, do not attempt to service or disassemble your shock. Attempting to service a shock that will not return to full extension can cause severe and/or fatal injuries.

### SAFETY INSTRUCTIONS

Always wear safety glasses and nitrile gloves when working with suspension grease and oil.

Place an oil pan on the floor underneath the area where you will be working on the shock.

### NOTICE

When replacing seals and o-rings, use your fingers or a pick to remove the seal or o-ring. Spray RockShox Suspension Cleaner or isopropyl alcohol on each part and clean with a shop towel. Apply grease to the new seal or o-ring. Only use RockShox Dynamic Seal Grease when servicing RockShox shocks.

To prevent damage to the shock use aluminium soft jaws and position the eyelet in the vise so that the adjustment knobs are clear of the vise jaws. For bearing mount shocks, wrap a shop towel around the eyelet, then clamp the eyelet flat into the vise.

Inspect each part for scratches. Do not scratch any sealing surfaces when servicing your suspension. Scratches can cause leaks.



- Adjust all damper settings to the open position.  
 Rotate the rebound adjuster knob counterclockwise until it stops, while counting the number of detent clicks. [Record this number](#) to assist you with post-service set up.



All

**Select RT (C2), Select+ RT (C1), Ultimate RC2T, Select+ RCT (C2):** Rotate the Threshold (pedal) lever to the open position.



Select RT (C2), Select+ RT (C1)



Ultimate RC2T, Select+ RCT (C2)

**Select+ RCT (C2), Ultimate RC2T, Ultimate DH RC2:** Rotate the Low Speed Compression (LSC) adjuster knob counterclockwise to the full open position and count the number of detent clicks. [Record this number](#) to assist you with post-service set up.



Ultimate RC2T, Select+ RCT (C2)



Ultimate DH RC2

**Ultimate RC2T, Ultimate DH RC2:** Rotate the High Speed Compression (HSC) adjuster counterclockwise to the full open position and count the number of detent clicks. [Record this number](#) to assist you with post-service set up.



Ultimate RC2T 3 mm



Ultimate DH RC2 3 mm

**2** **Record** your air pressure setting to assist with post-service set up.

Remove the air valve cap by hand. Use a small hex wrench to depress the Schrader valve and slowly release all air pressure from the air can.

**⚠ WARNING - PRESSURIZED DEVICE**

Always wear certified safety glasses (ANSI Z87.1, EN166 EU).

Verify all air pressure is removed from the suspension component. Failure to do so can result in **SERIOUS INJURY OR DEATH**. Refer to the Suspension Safety Precautions and Warnings section for detailed Pressurized Device warnings and instructions.

**⚠ CAUTION**

Do not disassemble a pressurized shock, this can cause the air can, suspension fluid, or debris to forcefully eject from the shock. Wear safety glasses.

Slowly release the air from the air can to make sure the air is removed from both chambers. Quickly releasing the air can trap air in the negative chamber and cause the air can to forcefully eject from the shock upon disassembly.

Use a RockShox Schrader Valve Tool to remove and reinstall the valve core from the valve body to make sure all air has been removed.

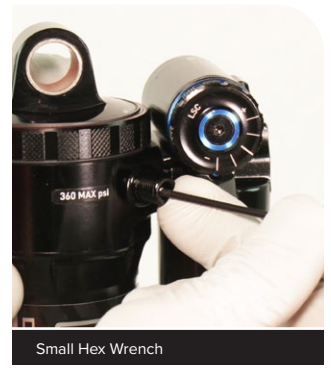

Small Hex Wrench



RockShox Schrader Valve Tool

**3** Clamp the shaft eyelet into a vise, with the shock positioned horizontally.

**NOTICE**

To prevent damage to the shock, use aluminum soft jaws and position the eyelet in the vise so that the adjustment knobs are clear of the vise jaws.



**4** Remove the sag indicator o-ring.



**5 Standard Eyelet:** Insert a cloth shop towel through the damper body eyelet to prevent the air can from forcefully ejecting from the shock.



**Bearing Eyelet:** If previously removed, install the bearing eyelet assembly onto the damper body. Wrap a cloth towel around the bearing eyelet assembly to protect it.



Bearing Eyelet 3 mm



Bearing Eyelet

**6** Use a rubber strap wrench to unthread the air can. Wrap the strap around the section of the air can furthest from the shaft eyelet. Firmly turn the wrench counterclockwise to unthread the air can.

**Linear XL Air Can:** Do not secure the rubber strap wrench around the air can sleeve.

Once it is completely unthreaded, firmly pull the air can toward the end of the damper body until there is a small gap between the air can and eyelet.

**Standard Eyelet:** Remove the shop towel from the damper body eyelet.

**Bearing Eyelet:** Remove the shop towel. Remove the bearing eyelet assembly from the damper body.



Rubber Strap Wrench Standard Air Can

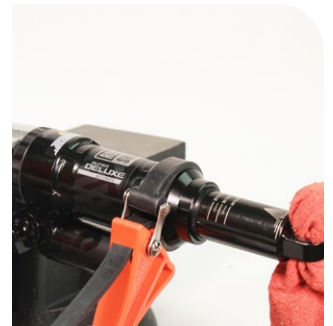

Rubber Strap Wrench Standard Air Can

### NOTICE

The air can must be clean and free of grease and oil. Clean the air can if necessary.

To avoid damage to the air can decal, do not place the strap wrench on the air can decal.



Rubber Strap Wrench Linear XL Air Can



Rubber Strap Wrench Linear XL Air Can



Standard Air Can



Linear XL Air Can

**7** Firmly pull the air can until it clears the sealhead / air piston and remove it from the shock.

**⚠ CAUTION - EYE HAZARD**

Vacuum pressure will increase as you pull the air can along the damper body, and will suddenly release when the air can is pulled off the air piston. Wear safety glasses.

Remove the Counter Measure assembly from the damper body.  
Set the air can and Counter Measure assembly aside.

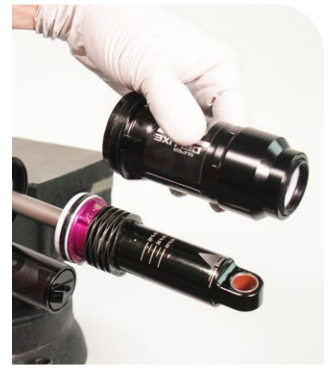

Counter Measure

## Bottomless Tokens and Travel Reducer

Bottomless Tokens reduce air volume in the rear shock air can and increase progression, or spring ramp, at the end of the shock's travel. Add or remove Bottomless Tokens to tune spring ramp.

Negative volume Tokens reduce negative air spring volume. Negative air spring volume influences initial and mid-stroke feel of the shock.

More negative air spring volume (negative volume Token removed) increases mid-stroke support and increases initial shock compression stroke sensitivity.

Less negative air spring volume (negative volume Token installed) reduces mid-stroke support and allows the bike to use more suspension travel on mid-sized bumps.

Bottomless Tokens can be added or removed at any time without performing a complete service.

2023+ (Gen C) Super Deluxe - only purple Bottomless Tokens are compatible.

Depending on the specification, a 2023+ (Gen C) Super Deluxe rear shock may include 0 - 4 Bottomless Tokens, 0 - 1 negative volume Tokens.

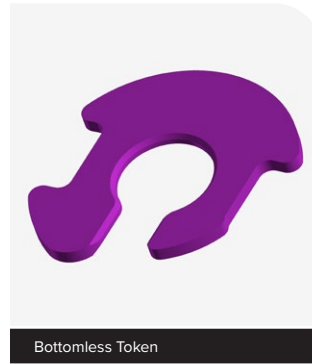

Bottomless Token

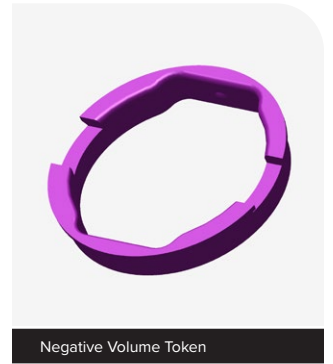

Negative Volume Token

**Linear XL Air Can:** A Linear XL air can may include 0 to 4 installed Linear XL air can Bottomless Tokens. Add or remove Bottomless Tokens to adjust spring feel.

Four Linear XL air can Bottomless Tokens are included with the Super Deluxe (Gen C) Linear XL Air Can Upgrade Kit. The Linear XL Air Can Upgrade Kit is NOT compatible with Super Deluxe Ultimate Flight Attendant.

It is recommended to install Linear XL air can Bottomless Tokens only if 4 purple eyelet Bottomless Tokens are installed.

**Upgrade Kit (optional)** - Air Can Upgrade Kit - Linear XL (37.5-45 mm, 47.5-55 mm, 57.5-65 mm)

The Linear XL Air Can Upgrade Kit is NOT available for 67.5 mm, 70 mm, 72.5 mm, and 75 mm stroke shock sizes.



Bottomless Token - Linear XL Air Can

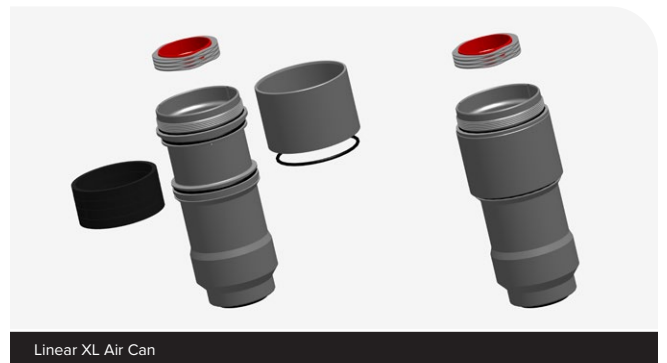

Linear XL Air Can

Some Super Deluxe rear shocks include a grey Travel Reducer which limits the compression stroke, or travel, as required for a particular bicycle frame. To change travel, install or remove, a Travel Reducer and the included washer.

### NOTICE

Before removing or installing Travel Reducers, consult your frame manufacturer. Frame size and design determine allowable shock travel, or stroke. Too much travel/stroke can cause damage to the shock or bicycle frame.

Shock Length (mm)	Shock Stroke (mm)	Travel Reducer (mm) (and travel reducer washer)
165, 190	37.5	7.5
	40	5
	42.5	2.5
	45	0
185, 210	47.5	7.5
	50	5
	52.5	2.5
	55	0
205, 230	57.5	7.5
	60	5
	62.5	2.5
	65	0
225, 250	67.5	7.5
	70	5
	72.5	2.5
	75	0

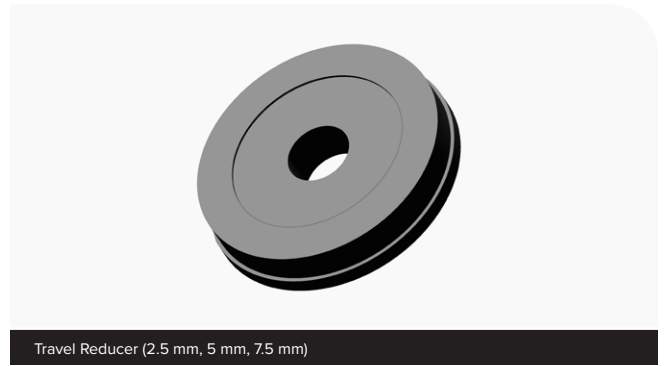

### 1 Install Bottomless Tokens:

Clamp the shaft eyelet into the vise.

Slide the bottomout washer and bumper up away from the shaft eyelet, then snap the Bottomless Token onto the damper shaft with the tabbed side facing the air valve.

Slide the Bottomless Token down the damper shaft until it contacts the other Bottomless Tokens or the eyelet.

Slide the bottomout washer and bumper down onto the top Bottomless Token.

Install up to four Bottomless Tokens.

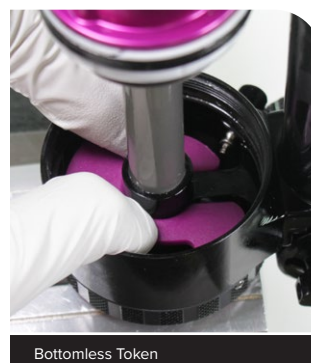
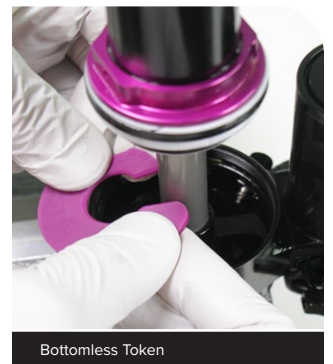

**Remove Bottomless Tokens:**

Clamp the shaft eyelet into the vise.

Move the bottomout washer and bumper up and away from the shaft eyelet. Use a pick to separate the Bottomless Token from the other Bottomless Tokens (if more than one are installed) or the shaft eyelet, then remove the Bottomless Token from the eyelet.

Slide the bottomout washer and bumper back down.

**NOTICE**

Do not scratch the damper shaft, shaft eyelet, or the eyelet o-ring. Scratches can cause leaks.

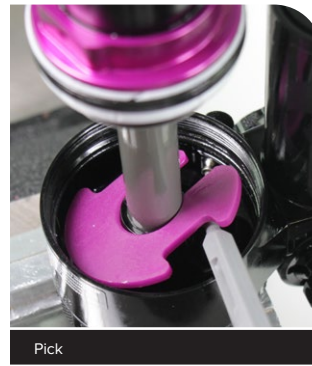

**2**

**Install Negative Volume Token:**

Align the flat inner sections of the negative volume Token with the flat outer sections of the sealhead / air piston. Snap the negative volume Token onto the sealhead / air piston.



**Remove Negative Volume Token:**

Carefully pry up and separate the negative volume Token from the sealhead / air piston. Remove the negative volume Token from the damper body.

**NOTICE**

Do not scratch the damper shaft. Scratches can cause leaks.



Procedures are the same for all air can configurations unless otherwise described and/or pictured.

- Slide the bottomout washer and bumper up.  
Remove the o-ring located below the shaft eyelet threads.

**NOTICE**

Do not scratch the sealhead. Scratches will cause leaks.

Clean the inside of the eyelet.

Apply grease to a new o-ring and install it into the eyelet.



Bottomless Token



Pick (non-metallic)

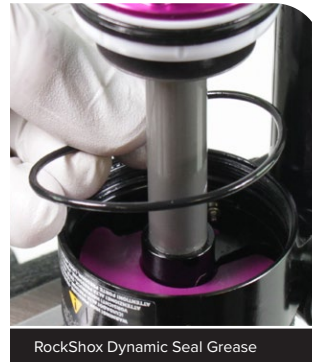

RockShox Dynamic Seal Grease



Push the bottomout washer and bumper back down.



- Remove and discard the air can wiper seal.



Pick (non-metallic)



- 3 Pierce, remove, and discard the quad ring seal.

**NOTICE**

Do not scratch the quad ring seal groove. Scratches will cause air to leak.

Do not damage or remove the white bushing. The bushing is factory fitted and installed, and does not require service.

The air can must be replaced if the inside surface is scratched and/or if the white bushing is removed.

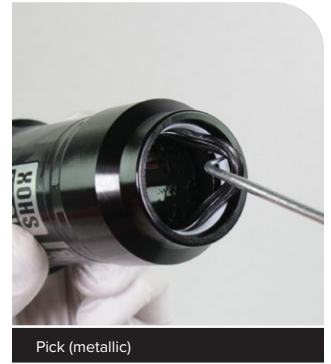

- 4 Clean the inside and outside of the air can.

Inspect the inside surface of the air can for scratches, dents, or deformations using a light. Replace the air can if it is scratched or damaged. Scratches will cause air to leak.

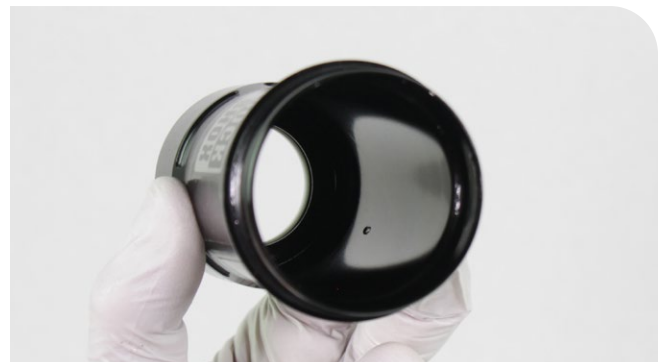
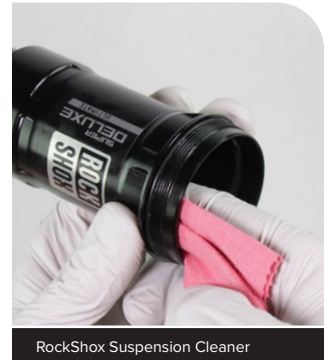
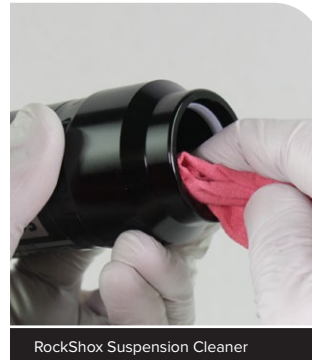

- 5** Apply grease to a new quad ring seal.  
Install the new quad ring seal by inserting one end into the seal groove in the air can, then push the remainder of the quad ring seal into the groove.

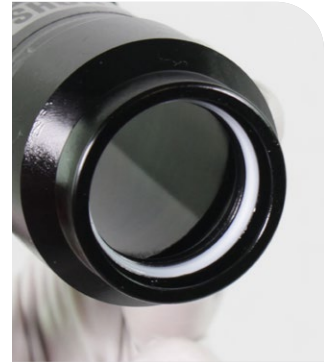
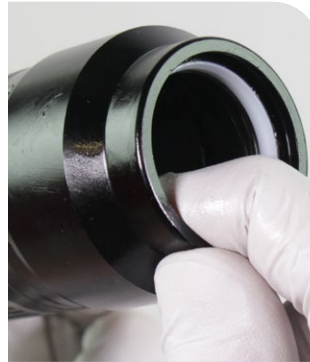
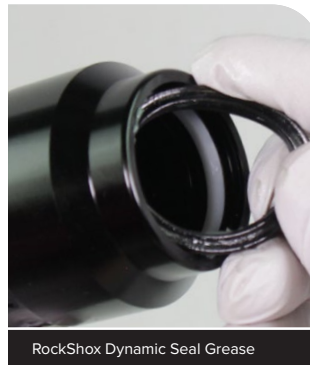

- 6** Install the new wiper seal into the air can.  
Apply grease to the quad ring seal, bushing, and wiper seal.

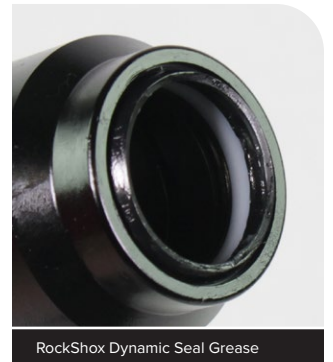

- 7 Remove the o-ring on the outside of the air can.  
Clean the air can and eyelet threads with a shop towel.  
Apply grease to a new o-ring and install it onto the air can.  
Apply grease to the air can threads.  
Set the air can aside.

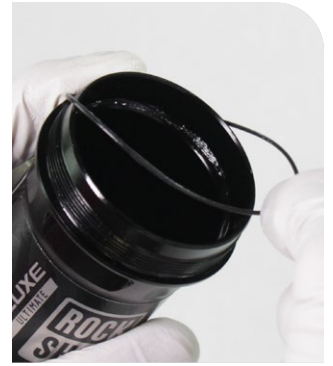
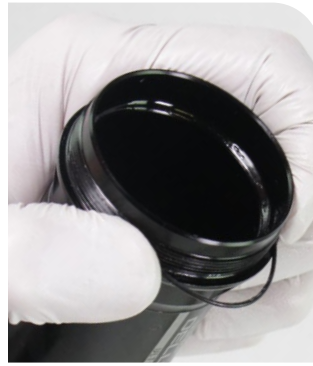

RockShox Dynamic Seal Grease

## Linear XL Air Can - Outer Sleeve Service and Tuning

In addition to requiring service, the Linear XL air can spring tune can be adjusted by removing or installing Linear XL air can Bottomless Tokens from and to the outer air can air chamber. The air can sleeve must be removed for Bottomless Token removal and installation, and to replace the two air can sleeve o-rings.

Upgrade (optional): If an Upgrade Linear XL Air Can is installed onto the shock, Bottomless Tokens can be installed before installation. The Upgrade Linear XL Air Can is NOT compatible with Super Deluxe Ultimate Flight Attendant.

- 1 Linear XL Air Can:** To remove the air can sleeve, push the air can sleeve o-ring from the o-ring groove with a non-metallic pick.



Pick (non-metallic)



Pick (non-metallic)

- 2** Secure a rubber strap wrench around the air can sleeve oriented in one direction. Secure a second rubber strap wrench to the air can oriented in the opposite direction.

Rotate each strap wrench in opposite directions to loosen the internal o-ring seal between the air can sleeve and the air can. After the seal has been loosened, rotate and push the air can sleeve away from the air can to remove it. Remove the air can sleeve.



Rubber Strap Wrench (x2)



Rubber Strap Wrench (x2)



Rubber Strap Wrench (x2)

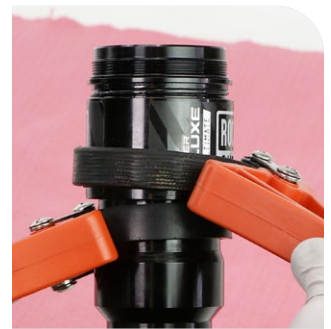

Rubber Strap Wrench (x2)



**3** Remove each sleeve o-ring and discard them.

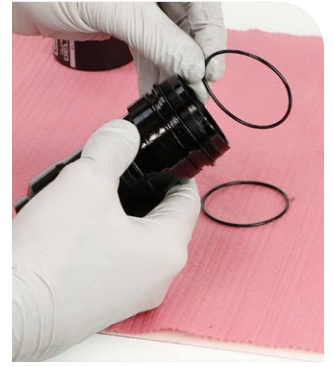
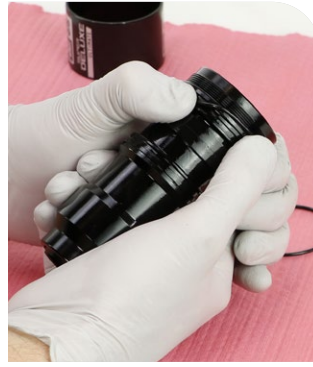
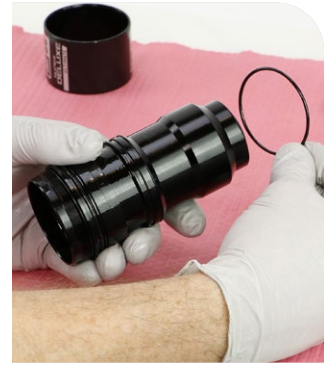

**4** Remove all installed Bottomless Tokens.

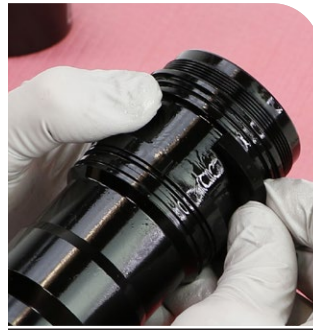

Rubber Strap Wrench (x2)

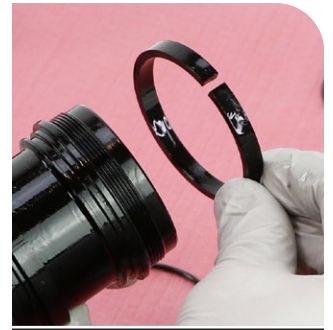

Rubber Strap Wrench (x2)

- 5** Clean the air can.  
Clean the air can sleeve.



RockShox Suspension Cleaner



RockShox Suspension Cleaner



RockShox Suspension Cleaner

- 6** Install up to four Bottomless Tokens.  
It is recommended to install Linear XL air can Bottomless Tokens ONLY if 4 purple eyelet Bottomless Tokens are installed.

**NOTICE**

To avoid permanent damage, do NOT install more than the maximum number of Bottomless Tokens.



Bottomless Token



Bottomless Token

**7** Apply grease to new air can sleeve o-rings and install them.

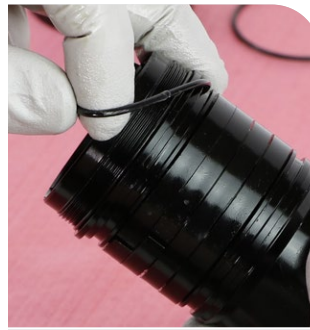

RockShox Dynamic Seal Grease

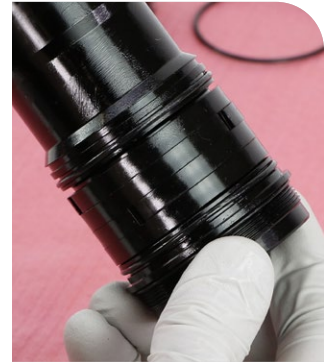
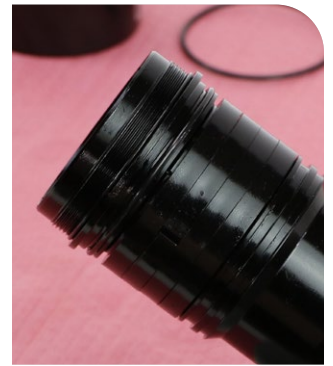

**8** Apply a thin layer of Maxima PLUSH Light Suspension Lube to the inside of the sleeve.



Maxima PLUSH Light



Maxima PLUSH Light

- 9 Install the sleeve onto the air can. Wrap a clean shop towel around the sleeve, place the air can on a flat surface, and press the sleeve onto the air can until it is fully seated.

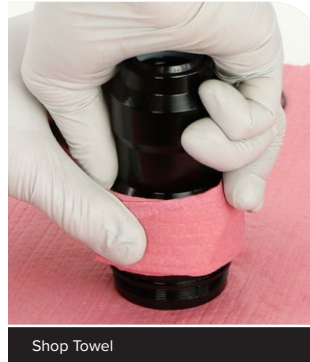

- 10 Install the outer air can o-ring.

**NOTICE**

The air can sleeve o-ring secures the sleeve onto the air can, and prevents air pressure loss. Confirm the o-ring is fully seated.

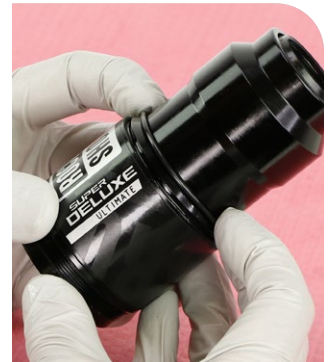

- 1** Clamp the shaft eyelet (standard or bearing) in the vise.  
Remove the split backup ring and sealhead / air piston quad ring seal.  
Clean the sealhead / air piston.

**NOTICE**

Do not remove or replace the (A) fixed sealhead backup ring. The fixed sealhead backup ring is sized at the factory and does not require service.

The sealhead must be replaced if the quad ring groove is scratched and/or if the (A) fixed backup ring is removed. If the sealhead must be removed, follow 200 hour service procedures for removal and installation.

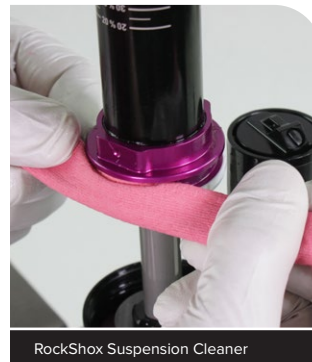

- 2** Apply grease to a new quad ring seal and install it onto the piston.  
Install a new split backup ring above the quad ring seal.



**50 Hour Service** To continue 50 Hour Service, go to [Air Can Installation](#).

**200 Hour Service** To continue 200 Hour Service, go to [IFP Reservoir Service](#).

**1** Clamp the shaft eyelet into the vise.

Remove the IFP reservoir valve cap. Depress the Schrader valve and release all air pressure from the IFP reservoir.

Once the pressure has been released, depress the Schrader valve a second time. If the Schrader valve is able to move, the shock has been completely depressurized.

**If the Schrader valve does not move at all, the shock is still pressurized and will need to be sent to an authorized RockShox service center for further service.**

**⚠ WARNING - PRESSURIZED DEVICE**

Always wear certified safety glasses (ANSI Z87.1, EN166 EU).

Verify all air pressure is removed from the suspension component. Failure to do so can result in **SERIOUS INJURY OR DEATH**. Refer to the Suspension Safety Precautions and Warnings section for detailed Pressurized Device warnings and instructions.

**⚠ CAUTION - EYE HAZARD**

Verify all pressure is removed from the shock before proceeding. Failure to do so can cause the damper body to separate from the shaft eyelet at a high velocity. Wear safety glasses.

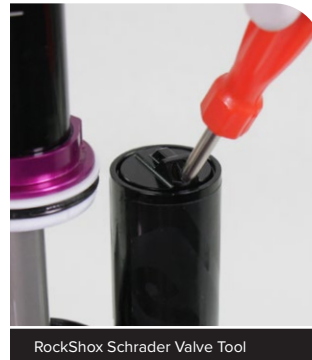

RockShox Schrader Valve Tool

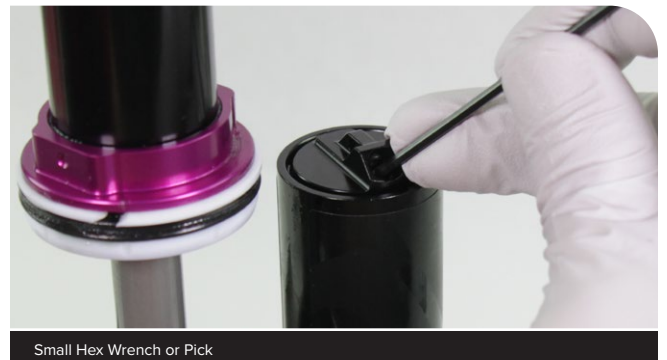

Small Hex Wrench or Pick

**2** Remove the Schrader valve core from the IFP reservoir valve cap and set it aside.

*Do not discard the Schrader valve core.*

**⚠ WARNING - PRESSURIZED DEVICE**

Always wear certified safety glasses (ANSI Z87.1, EN166 EU).

Verify all air pressure is removed from the suspension component. Failure to do so can result in **SERIOUS INJURY OR DEATH**. Refer to the Suspension Safety Precautions and Warnings section for detailed Pressurized Device warnings and instructions.

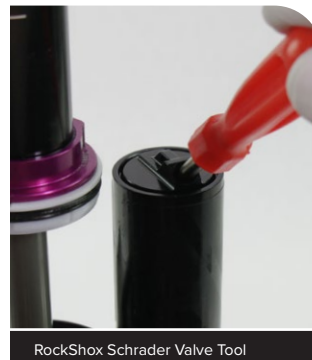

RockShox Schrader Valve Tool

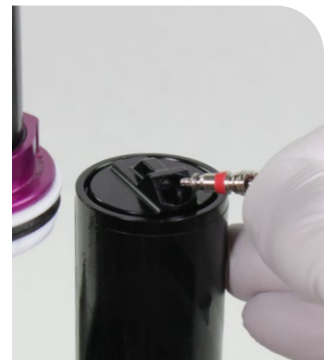
**3** Push the IFP reservoir cap into the reservoir until it stops.

**4** Remove the retaining ring from the IFP reservoir.

**⚠ CAUTION - EYE HAZARD**

The retaining ring can eject rapidly as it is removed. Wear safety glasses.

**NOTICE**

Do not scratch the inside of the IFP reservoir. Scratches will cause oil and air to leak.

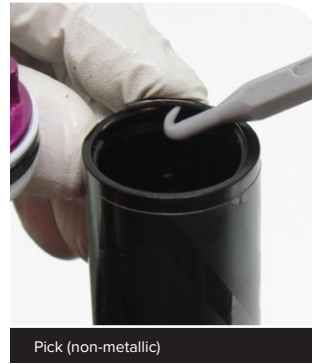

**5** Remove the IFP reservoir cap from the IFP reservoir.

**NOTICE**

Do not scratch the inside of the IFP reservoir. Scratches will cause oil and air to leak.

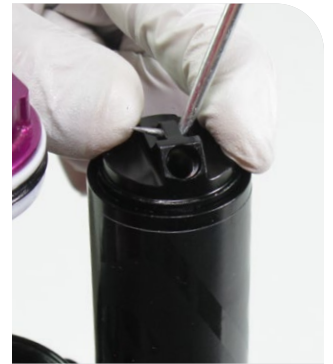
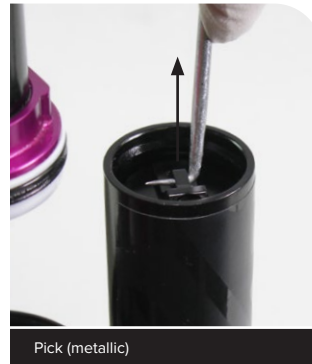

- 6** Remove the IFP reservoir cap o-ring and discard it.  
Apply grease to a new o-ring and install it.

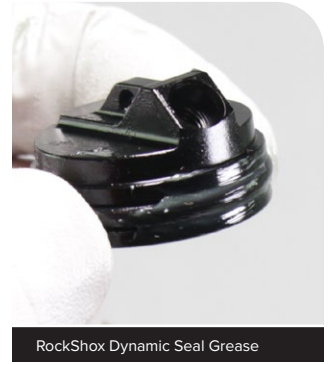
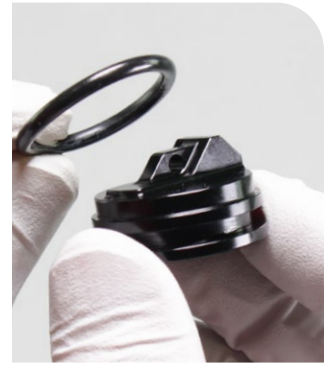
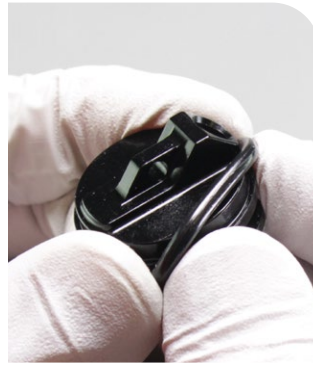

- 7** Unthread the IFP bleed screw.  
Apply a dab of grease to the end of the TORX T10 wrench.  
Remove the IFP bleed screw.

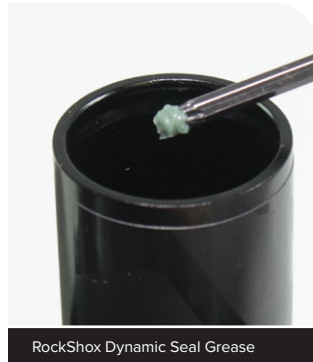

**8** Thread the RockShox IFP Puller Tool into the IFP, then remove the IFP Puller Tool and IFP from the reservoir.

Unthread the RockShox IFP Puller Tool from the IFP.

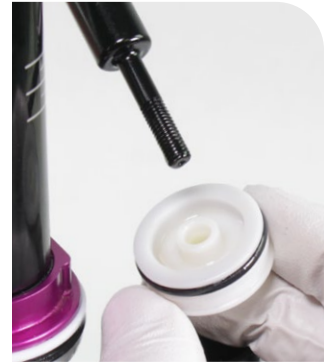
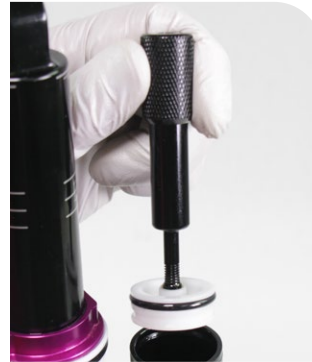
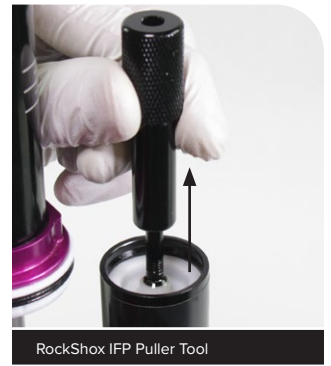
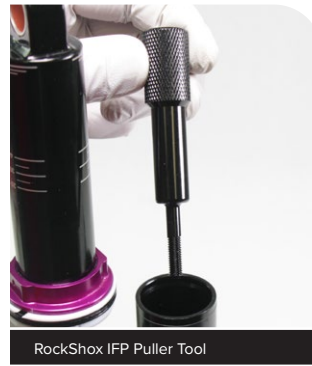

**9** Remove the IFP o-ring and discard it.

Clean the IFP.

Apply grease a new o-ring and install it onto the IFP.

Set the IFP aside.

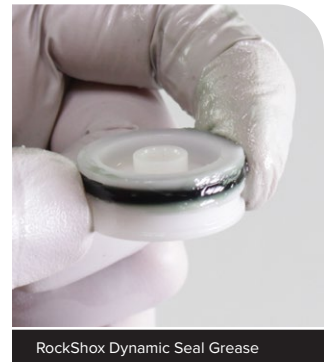

**10** Remove the shock from the vise and pour the oil from the reservoir into an oil pan.



All procedures are the same for Select R, Select+ RT, Ultimate RC2T, Ultimate RC2T AirWiz, and Ultimate DH RC2 unless otherwise described and/or pictured.

**Super Deluxe Ultimate RC2T AirWiz:** Do not remove the AirWiz electronics cover during service. Removal during service can result in permanent damage to the internal electronic components. Do not clamp the AirWiz electronics cover in a vise.

- 1 Clamp the damper body eyelet (standard or bearing) into the vise.  
Wrap a shop towel around the damper body below the sealhead / air piston assembly, and on the vise, to absorb oil.  
Place an oil pan beneath the damper body.



- 2 Hold the damper body below the sealhead / air piston. Stabilize the wrench with your hand to prevent the wrench from slipping and scratching the damper shaft.  
Unthread the sealhead / air piston assembly from the damper body.  
By hand, remove the sealhead / air piston assembly from the damper body. Carefully remove the damper piston and damper assembly from the damper body and set it aside.

**⚠ WARNING - PRESSURIZED DEVICE**

Always wear certified safety glasses (ANSI Z87.1, EN166 EU).

**NOTICE**

Do not scratch the damper body while removing the sealhead / air piston. Scratches can cause leaks.

To prevent damage to the damper body, do not allow the wrench to slip from the sealhead / air piston.

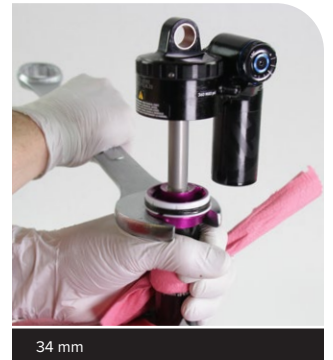
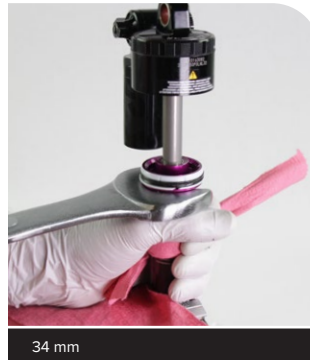

- 3 Remove the damper body from the vise and pour the oil into an oil pan.



**4** Spray RockShox Suspension Cleaner inside the damper body.

Place the damper body vertically onto a shop towel and allow the excess oil and cleaner to drain.

Inspect the inside and outside surfaces of the damper body for scratches, dents, or other surface deformations with a light. If any deformations are found, the damper body will need to be replaced.



RockShox Suspension Cleaner

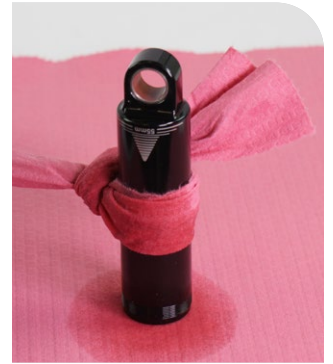

Light

**5** Clean the damper shaft assembly and vise blocks to remove any oil or grease.

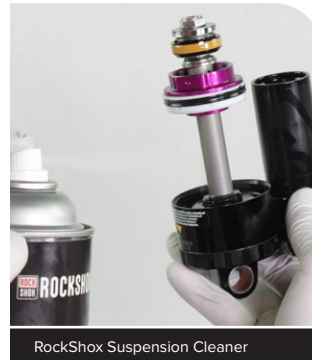

RockShox Suspension Cleaner

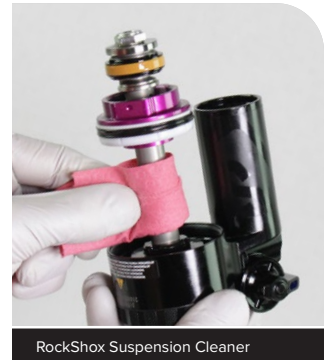

RockShox Suspension Cleaner

**6** Position the sealhead / air piston assembly above the vise block.

Clamp the damper shaft into the 1/2 inch / 12.7 mm vise block slot, tight enough so it does not spin when the piston bolt is removed.

**NOTICE**

To prevent damage to the sealhead / air piston, position the sealhead / air piston below the damper piston and above the vise blocks.



RockShox Rear Shock Vise Blocks 3-hole - 1/2 inch / 12.7 mm slot

- 7** Loosen the damper piston bolt one full rotation.  
Loosen only; do not remove the piston bolt.

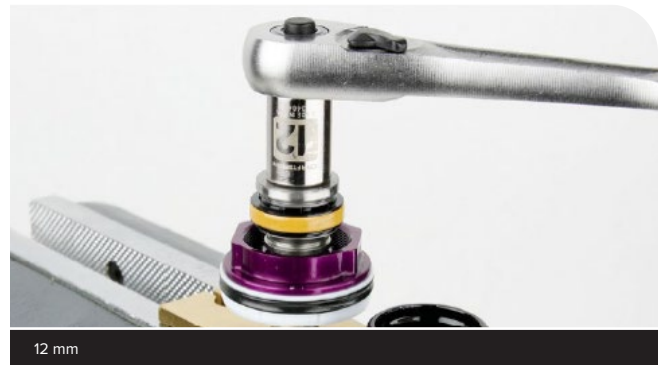

- 8** Remove the damper assembly from the RockShox vise blocks. Clamp the eyelet into the flat soft jaws.  
Unthread the piston bolt completely by hand; do not remove.  
Slide the sealhead / air piston down.  
Insert a small hex wrench or pick through the center of the piston bolt.  
Press the piston bolt (A) down and the top out plate (B) up to keep all the piston assembly parts together during removal.  
Remove the piston bolt and piston assembly together on the hex wrench or pick to keep all parts together. Set the piston assembly, on the pick, aside.

### NOTICE

Keep the piston assembly parts in the order they were removed. Do not separate any parts from the piston assembly.

If any piston assembly parts are installed in the incorrect order, the piston assembly, including the tune shim stacks, must be reassembled in the correct order to ensure proper function. Refer to the *Rear Suspension Shim Tuning Guide* for piston assembly and shim stack arrangements.

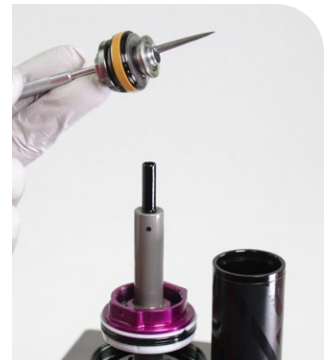
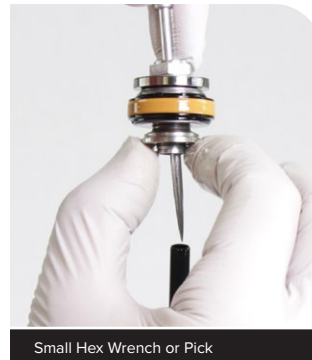
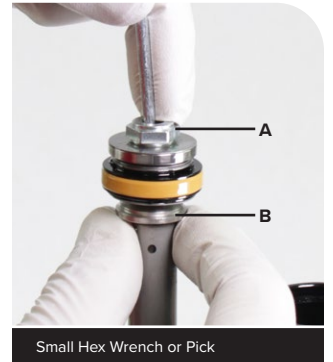

- 9** Remove the sealhead / air piston from the damper shaft.

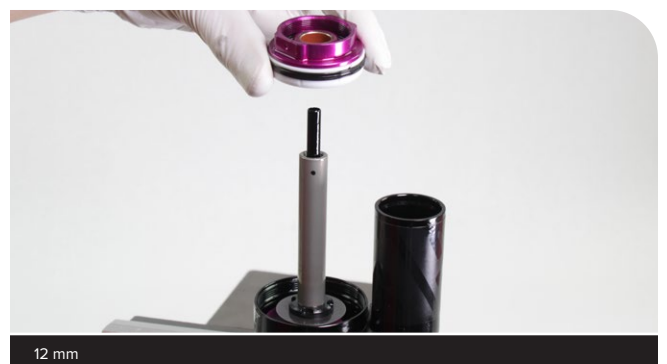

- 10** Remove and discard the bottomout bumper.  
Remove the washer.  
Clean the damper shaft.  
If travel will NOT be changed, proceed to step 12.

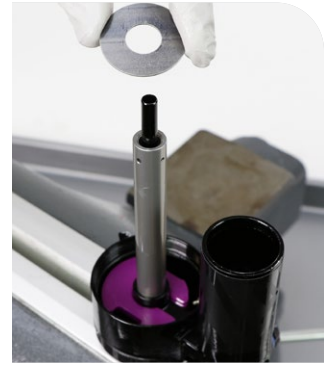

RockShox Suspension Cleaner

**11 Travel Change (optional):** Travel within the shock stroke range is changeable by installing a Travel Reducer and washer. Refer to the table below for compatibility. Refer to the *RockShox Spare Parts Catalog* for the available Super Deluxe (Gen C) Travel Change kit.

To change travel, install or remove a Travel Reducer and the included washer before the washer and bottomout bumper are installed.

Installation - install the Travel Reducer on top of the washer. Install the additional washer (included in the travel change kit) on top of the Travel Reducer.

**NOTICE**

Before increasing or reducing shock travel (stroke), consult your frame manufacturer. Frame size and design determine allowable shock travel (stroke). Too much travel (stroke) can cause damage to the shock or bicycle frame.

Shock Length (mm)	Shock Stroke (mm)	Travel Reducer (mm) (and travel reducer washer)
165, 190	37.5	7.5
	40	5
	42.5	2.5
	45	0
185, 210	47.5	7.5
	50	5
	52.5	2.5
	55	0
205, 230	57.5	7.5
	60	5
	62.5	2.5
	65	0
225, 250	67.5	7.5
	70	5
	72.5	2.5
	75	0

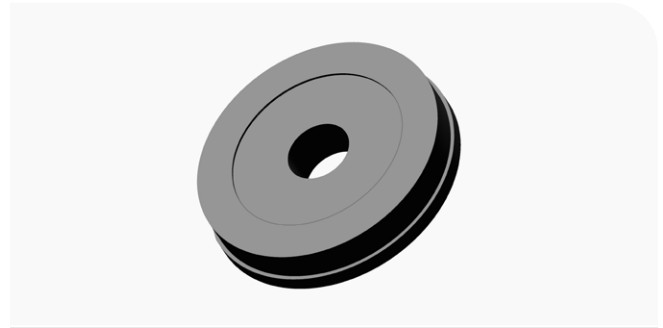

Travel Reducer (2.5 mm, 5 mm, 7.5 mm)



Washer



Travel Reducer (2.5 mm, 5 mm, 7.5 mm)



Travel Reducer (2.5 mm, 5 mm, 7.5 mm)

**12** Install the washer and a new bottomout bumper.



## Upgrade (optional) Super Deluxe C2 Ultimate RC2T Reservoir

Super Deluxe C1-C2 shock models (excluding Ultimate Flight Attendant) can be upgraded with the Super Deluxe C2 Ultimate RC2T Reservoir Upgrade kit, available separately.

The Ultimate RC2T Upgrade Reservoir is NOT compatible with Super Deluxe Ultimate Flight Attendant.

Upgrade requires removal of the original reservoir assembly and installation of the upgrade (Ultimate RC2T) reservoir. If the reservoir assembly is upgraded, shock disassembly is required. It is recommended to also complete 200 hour service and replace all service parts while the shock is disassembled.

Vivid Air C1 is pictured. Procedures are the same for Super Deluxe (Gen C).

- 1 Select RT:** Loosen the lever set screw.  
Remove the lever.

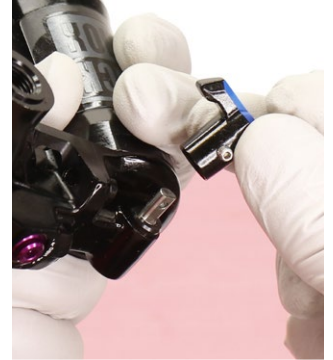
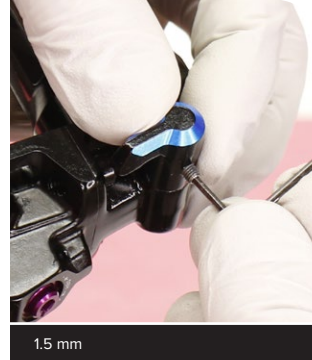

- 2 Select RT, Base R:** Remove each reservoir bolt.  
Remove the reservoir assembly from the eyelet.

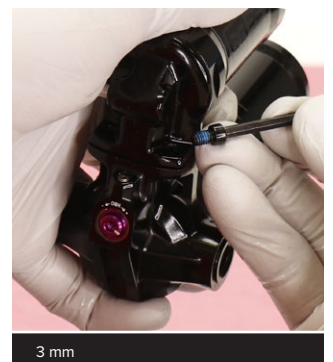
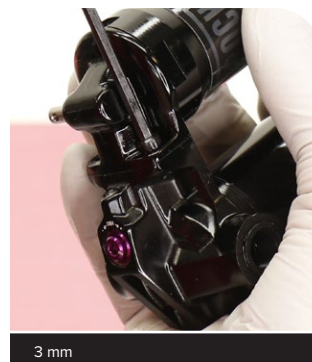

**3** **Select+ RCT, Ultimate DH RC2, :** Unthread the (A) left exposed reservoir bolt (3 mm).

Unthread the (B) right hidden reservoir bolt (3 mm).

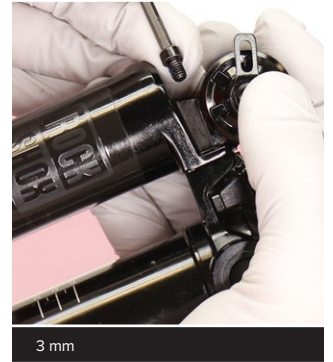
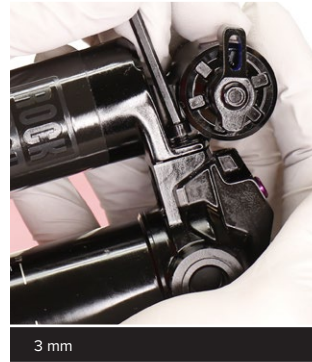
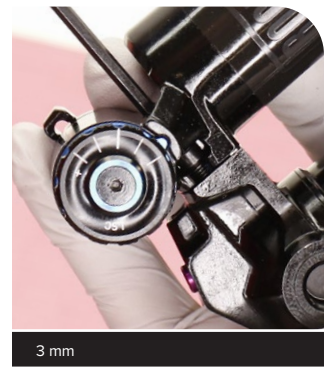

Lift the reservoir assembly away from the eyelet and slide it to the left until the slotted bolt groove in the neck clears the hidden reservoir bolt head.



Remove the left reservoir bolt and reservoir assembly.

Remove the remaining (right) reservoir bolt.

Remove the reservoir assembly from the eyelet.



- 4** Remove the alignment pin and reservoir o-ring.  
Clean the pin and o-ring. Clean the pin and o-ring groove.  
Reinstall the pin and o-ring back onto the eyelet (no grease).

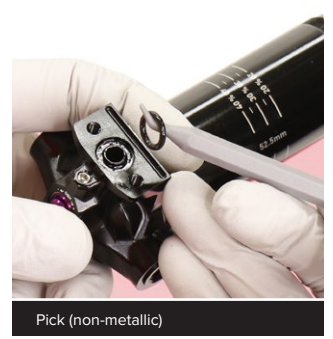

Pick (non-metallic)

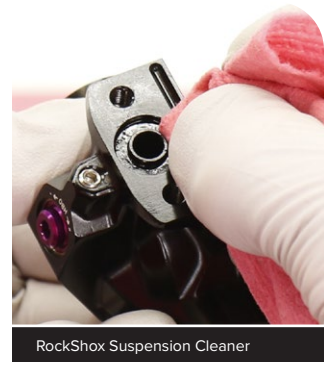

RockShox Suspension Cleaner



No grease

**5 Ultimate RC2T Upgrade Installation:** Thread the right side reservoir bolt into the eyelet until the bolt head is about 3 mm from contacting the damper body.

Position the slotted bolt groove in the Ultimate RC2T reservoir neck around the reservoir bolt head (partially threaded into damper body), slide the reservoir to the right, and align the reservoir neck, onto the eyelet, with the bolt hole on the Threshold lever side.

Insert the other reservoir bolt into the bolt hole and thread the bolt into the damper body until it contacts the reservoir neck. Thread the hidden bolt into the eyelet until it contacts the reservoir neck.

Tighten each bolt to the specified torque.

**⚠ WARNING - CRASH HAZARD**

Parts must be tightened to the specified torque. Failure to do so can result in SERIOUS INJURY OR DEATH.

Adjust all compression settings to the open position before shock assembly.

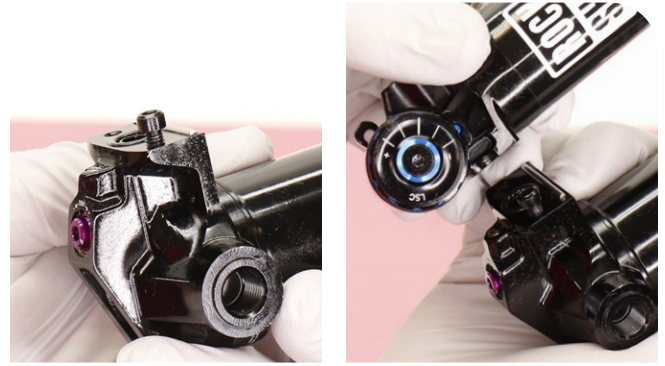

2.8 N·m (25 in-lb)



2.8 N·m (25 in-lb)

- 1** Remove the sealhead / air piston internal o-ring seal and discard it.  
Clean the o-ring groove.

**NOTICE**

Do not scratch the sealhead. Scratches will cause leaks.

The sealhead must be replaced if the o-ring groove is scratched.

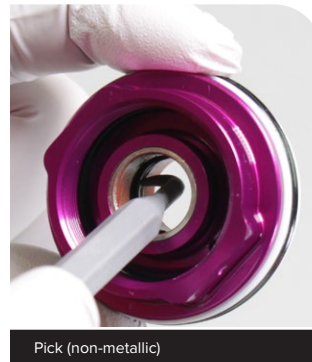

Pick (non-metallic)

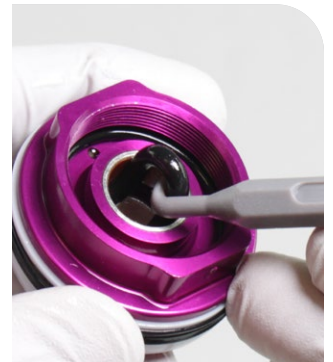

Apply grease to a new internal o-ring and install it.

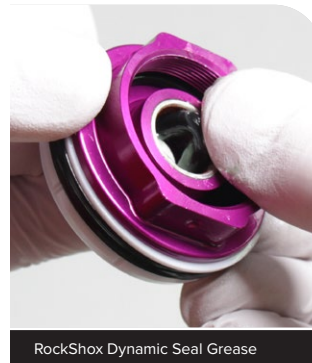

RockShox Dynamic Seal Grease

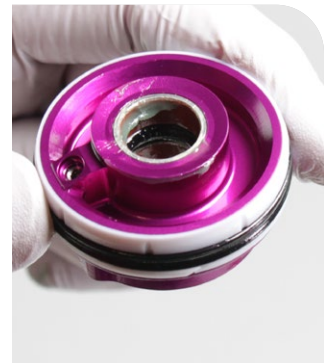

- 2** Remove the inner o-ring from the underside of the sealhead / air piston and discard it.

Clean the o-ring groove.

**NOTICE**

Do not scratch the sealhead. Scratches will cause leaks.

The sealhead must be replaced if the o-ring groove is scratched.

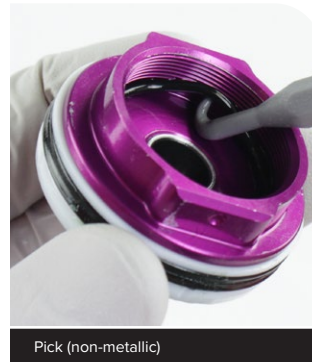

Pick (non-metallic)

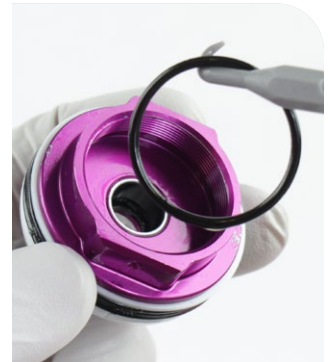

Apply grease to a new a new inner o-ring and install it.



RockShox Dynamic Seal Grease

- 3** Remove the split backup ring and sealhead / air piston quad ring seal, and discard them.

Clean the sealhead / air piston.

**NOTICE**

Do not remove or replace the (A) fixed sealhead backup ring. The fixed sealhead backup ring is sized at the factory and does not require service.

The sealhead must be replaced if the quad ring groove is scratched and/or if the (A) fixed backup ring is removed.

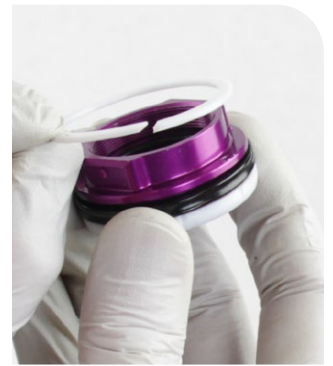

- 4** Apply grease to a new quad ring seal and install it.  
Install a new split backup ring above the quad ring seal.



- 1 Slide the washer and bumper down.  
Apply grease to the sealhead / air piston inner o-ring and bushing.  
Install the sealhead / air piston assembly onto the damper shaft.

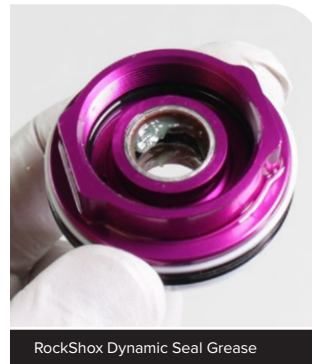

- 2 Remove the excess grease from the end of the damper shaft.



- 3 Position the sealhead / air piston just below the end of the end of the damper shaft.  
Clean the damper shaft and remove any grease so the damper shaft does not spin in the vise blocks.

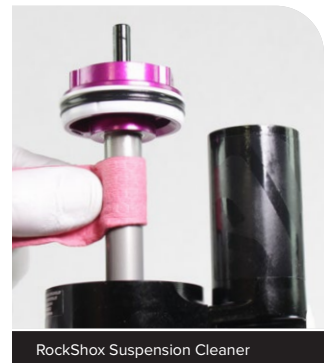

**4** With the sealhead / air piston positioned above the vise blocks, clamp the damper shaft into the 1/2" / 12.7 mm vise block slot, tight enough so it does not spin.



RockShox Rear Shock Vise Blocks 3-hole - 1/2" / 12.7 mm slot

**5** Compress all of the piston assembly parts together on the piston bolt with the small hex wrench or pick through the piston bolt.

**Keep the damper piston assembly parts in the same order.**

While holding the top out plate (A), guide the piston assembly centered onto the damper shaft. When the piston assembly parts are all centered on the damper shaft, thread the piston bolt into the damper shaft until finger tight.

Remove the pick when the piston bolt is finger tight.

**Piston Upgrade (optional):** All Super Deluxe C1 shocks can be upgraded with the Super Deluxe C2 High Flow Damper Piston Assembly kit which includes the Super Deluxe C2 High Flow piston, rebound check plate, top out plate, and piston bolt, and the correct shims included in the Super Deluxe C Gen Damper Shim Tune kit.

Arrange the C2 high flow piston assembly parts, and shim tunes, in the correct order and slide them onto a pick for shock reassembly.

Refer to the *RockShox Rear Suspension Shim Tuning Guide* for the correct part installation order, including all tune shims required for the C2 high flow damper piston assembly.

Refer to the *RockShox Spare Parts Catalog* for available upgrade kits.



Small Hex Wrench or Pick

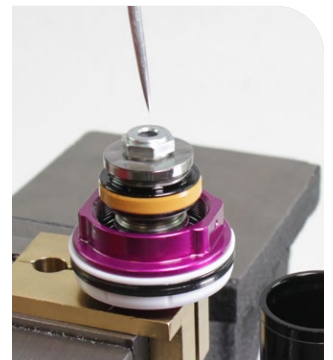
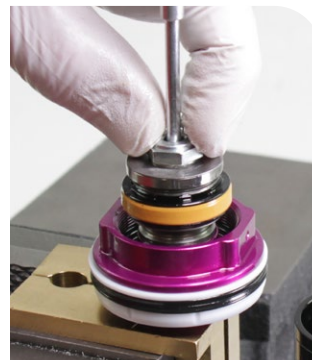
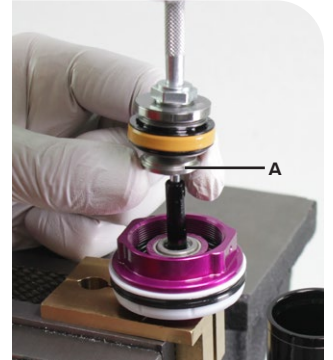

Damper	Shim Tune - Super Deluxe C1	Shim Tune - Super Deluxe C2
	Rebound	Linear - LN
Linear - HLN		
Linear - LLN		R53
Digressive - DG		R85
Progressive - PR		R25
Compression	LC	C30
	L1	C34
	L	C37
	M	C40
	H	C43

**NOTICE**

Keep the piston assembly parts in the order they were removed. Do not separate any parts from the piston assembly.

If the shims are not centered and in the correct order, the shock will not perform properly. If any piston assembly parts are installed in the incorrect order, the piston assembly, including the tune shim stacks, must be reassembled in the correct order to ensure proper function. Refer to the Rear Suspension Shim Tuning Guide for piston assembly and shim stack arrangements.

**6** Tighten the piston bolt.

**⚠ WARNING - CRASH HAZARD**

Parts must be tightened to the specified torque. Failure to do so can result in **SERIOUS INJURY OR DEATH**.

Remove the assembly from the vise.



- 1 Secure a shop towel around the reservoir to absorb oil.



- 2 Pour Maxima PLUSH 7wt Suspension Oil into the IFP reservoir until it is approximately 5 mm below the top of the IFP reservoir.

**CAUTION**

Always wear safety glasses. Do not allow oil, fluid, grease, lubricant, or cleaner to contact your eyes or face. Seek immediate medical attention if irritation occurs.



Maxima PLUSH 7wt Suspension Oil



5 mm

- 3 Tap down on the top of the reservoir with your hand a few times to move oil through the damper shaft. This will assist in purging air bubbles from the system.

Continue to tap on the top of the reservoir until no more bubbles purge from the damper shaft.

Once the system is purged of bubbles, cover the damper shaft / piston bolt hole with your thumb to temporarily seal the system.

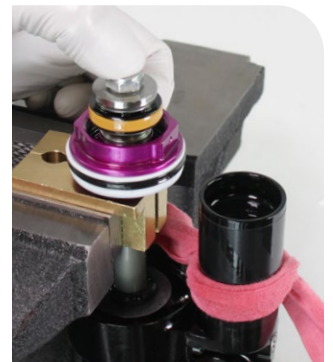
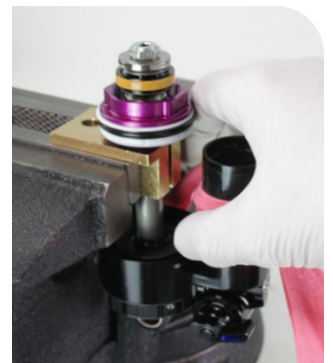

**4** With your thumb still on the damper shaft / piston bolt hole, place the IFP, o-ring end outward/up, into the IFP reservoir evenly.

**⚠ CAUTION**

Always wear safety glasses. Do not allow oil, fluid, grease, lubricant, or cleaner to contact your eyes or face. Seek immediate medical attention if irritation occurs.

Place a shop towel over the IFP to absorb oil that may purge from the IFP bleed hole.

Do not completely cover the IFP bleed hole in the center of the IFP with your finger or thumb when installing the IFP. Oil will purge through the IFP bleed hole when it is installed.

With your finger and thumb, slowly push the IFP into the reservoir just enough for the o-ring to clear the end of the reservoir can. Stop when you feel the o-ring clear the edge of the reservoir can. Remove the shop towel.

Place the RockShox IFP Height Tool V2 (Super Deluxe) onto the IFP. Slowly and carefully, push down on the IFP tool to push the IFP into the reservoir to a depth of approximately 20 mm (use a ruler or the 39 mm or 41 mm mark for scale). Oil may purge from the bleed holes in the IFP tool.

**20 mm depth is NOT the final IFP depth. Final IFP depth will be set after the piston/shaft assembly has been installed.**

Remove the IFP Height Tool V2. Do not remove your thumb from the damper shaft / piston bolt hole.

The IFP should be submerged in oil.

**⚠ CAUTION- EYE HAZARD**

Oil may eject from the IFP if you push the damper too fast. Do not look directly into the reservoir or IFP Height Tool V2 as you push the IFP down. Wear safety glasses.

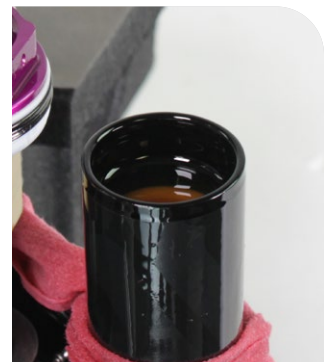
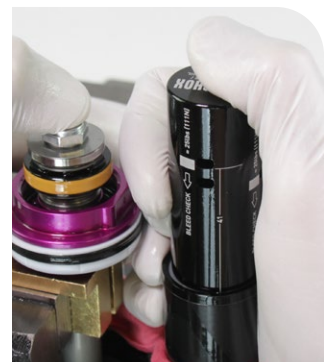
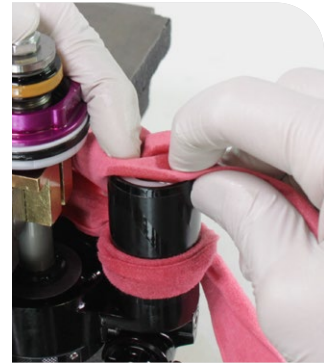

- 5** With your thumb still covering the damper shaft / piston bolt hole, lightly tap the end of the eyelet and the end of the reservoir with a (A) plastic wrench handle to purge any remaining air bubbles.



- 6** Apply a dab of grease on the end of the TORX T10 wrench to hold the bleed screw on the wrench, and carefully install the IFP bleed screw into the IFP.

Tighten the bleed screw and stop when the IFP starts to spin. Resistance will be felt just before the IFP starts to spin.

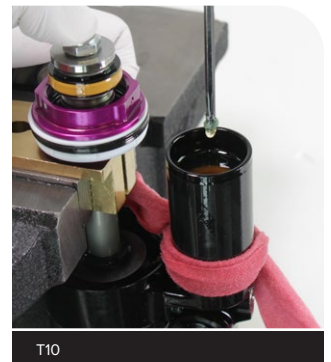
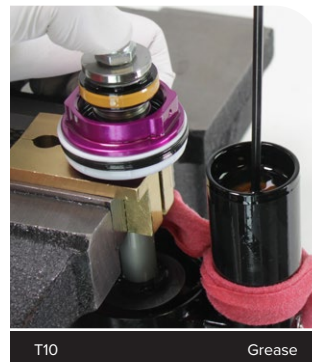
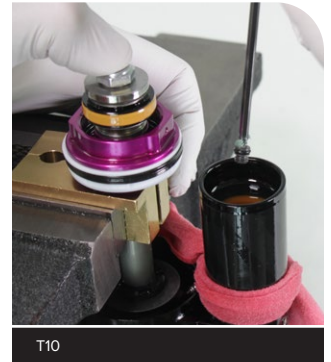
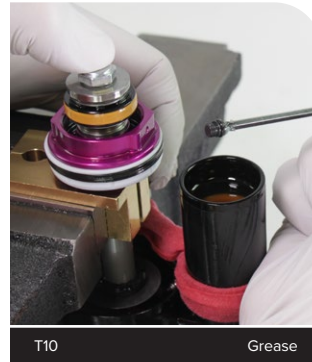

- 7** Remove the shock from the vise, cover the damper shaft / piston bolt hole, and pour out the excess oil from the reservoir into an oil pan.

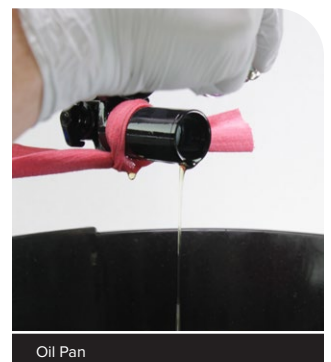
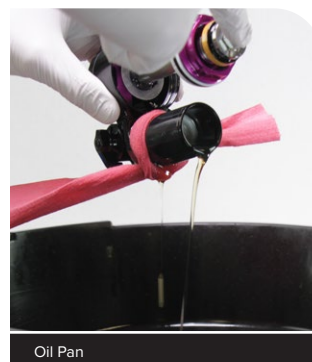

- 8** Slide the sealhead / air piston to the damper piston until it stops.  
Set the eyelet / damper assembly aside, oriented vertically.

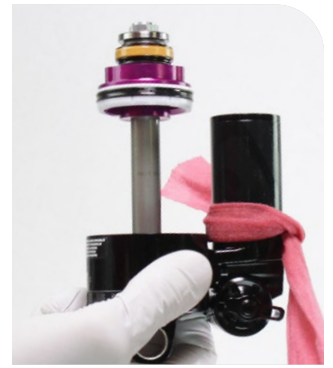

- 9** Clamp the damper body eyelet into the vise.  
Secure a shop towel around the damper body to absorb oil.



- 10** Pour Maxima PLUSH 7wt Suspension Oil into the damper body until it is level with the top.

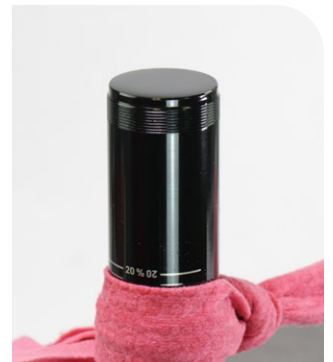

**11** Place your thumb in the reservoir against the IFP to prevent it from moving.

While holding the sealhead / air piston down and against the damper piston, slowly install the damper piston into the damper body, and the sealhead / air piston onto the damper body.

By hand, thread the sealhead / air piston assembly onto the damper body.

Oil pressure will increase against the IFP as the sealhead / air piston assembly is threaded onto the damper body. Keep your thumb against the IFP, applying opposing pressure, to ensure the IFP does not move during installation. This ensures a proper bleed.

Remove your thumb only after the sealhead / air piston assembly has been threaded onto the damper body, by hand, until it stops.



**12** Hold the damper body below the sealhead / air piston. Stabilize the wrench with your hand to prevent the wrench from slipping and scratching the damper shaft.

Tighten the sealhead / air piston.

**⚠ WARNING - CRASH HAZARD**

Parts must be tightened to the specified torque. Failure to do so can result in SERIOUS INJURY OR DEATH.

Clean the damper body and wipe away any excess oil.

**NOTICE**

Do not scratch the damper shaft while tightening the sealhead / air piston. Scratches can cause leaks.

To prevent damage to the damper body, do not allow the wrench to slip from the sealhead / air piston.

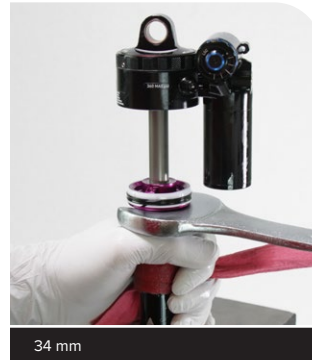

34 mm

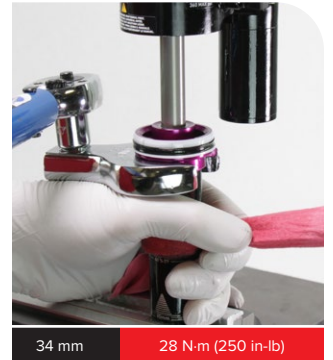

34 mm

28 N·m (250 in·lb)

**13** Remove the shock from the vise. Remove the shop towel. Turn the shock over and clamp the shaft eyelet into the vise.



- 14** Apply a dab of grease to the end of the TORX T10 wrench.  
Carefully, and without pushing down on the IFP, remove the IFP bleed screw from the IFP.

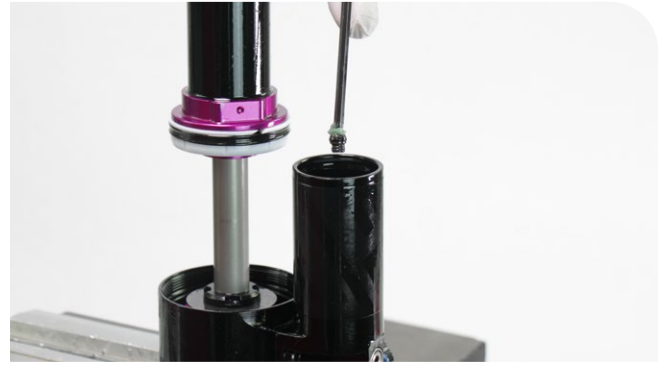

- 15** Place the RockShox IFP Height Tool V2 (Super Deluxe) into the reservoir and onto the IFP.  
Slowly and carefully, push down on the tool to push the IFP into the reservoir, back down to a depth of approximately 20 mm (use a ruler or the 39 mm or 41 mm mark for scale). Oil may purge from the bleed holes in the IFP tool.

Remove the IFP tool.

The IFP should be submerged in oil.

**20 mm depth is NOT the final IFP depth. Final IFP depth will be set after the piston/shaft assembly has been installed.**

**⚠ CAUTION- EYE HAZARD**

Oil may eject from the IFP if you push the damper too fast. Do not look directly into the reservoir or IFP Height Tool V2 as you push the IFP down. Wear safety glasses.

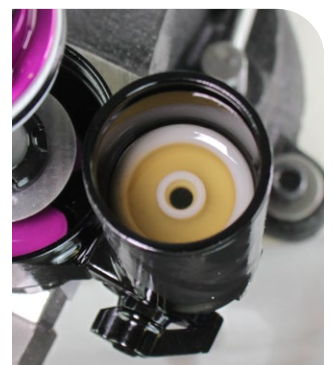
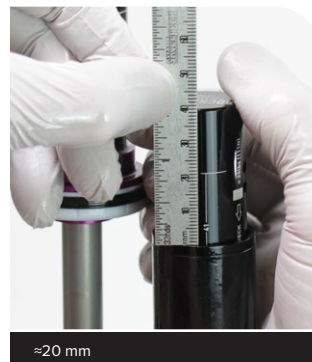
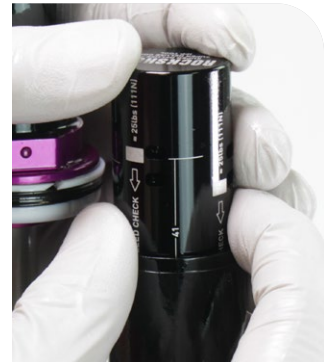
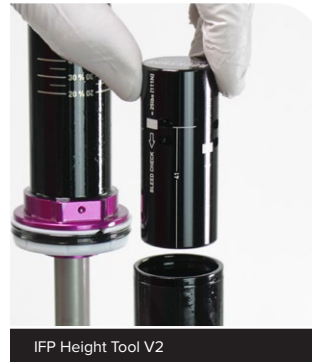

- 16 If the IFP is not submerged in oil, pour Maxima PLUSH 7wt Suspension Oil into the damper body until the IFP is submerged.



- 17 Hold a shop towel over the reservoir. Slowly push the damper body downward. Oil will begin to fill the reservoir through the IFP bleed port. Stop when the damper body is 3/4 of the way through the travel.

**⚠ CAUTION - EYE HAZARD**

Do not look directly into the reservoir as the damper body is pushed down. Oil may eject from the IFP reservoir if you push the damper too fast. Wear safety glasses.



- 18 Slowly pull up on the damper body until it stops, making sure the IFP stays submerged in oil. This will cycle oil from the reservoir back into the damper body and purge air bubbles from the system. Continue to slowly pull up and push down on the damper body until no more air bubbles emerge from the IFP bleed port.

**⚠ CAUTION- EYE HAZARD**

Do not look directly into the reservoir as you push on the damper body. Oil may be ejected from the IFP reservoir if you push the damper down too fast. Wear safety glasses.

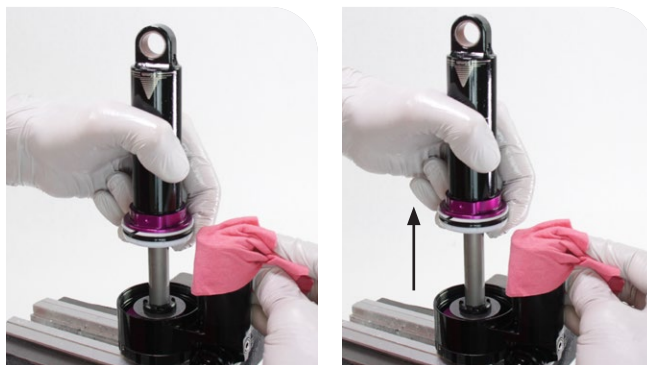

**19** Apply a dab of grease to the end of the TORX T10 wrench to secure the IFP bleed screw.

Carefully install the IFP bleed screw into the IFP. Tighten the bleed screw and stop when the IFP starts to spin.

The bleed screw should be submerged in oil.

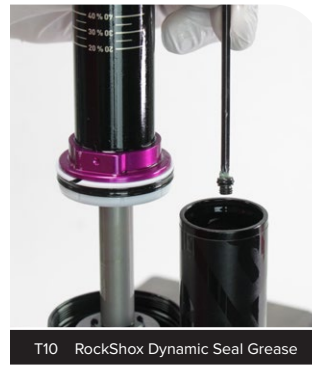

T10 RockShox Dynamic Seal Grease



**20** Secure a shop towel around the damper body to absorb oil. Remove the damper body bleed screw from the damper body eyelet. Secure the shop towel over the bleed port after the bleed screw is removed. Secure a shop towel around the reservoir to absorb oil.

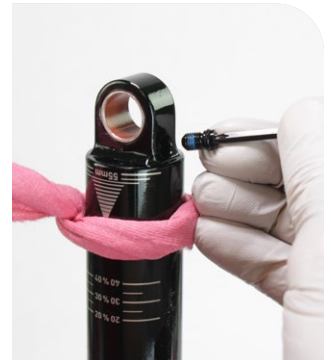
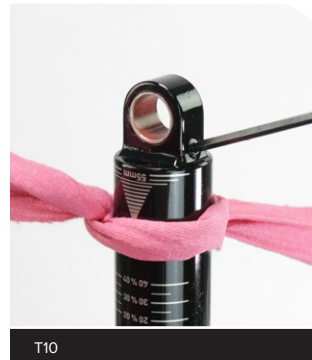

T10



**21 Set IFP to Specified Depth:** Insert a 3 mm hex wrench through the slot in the RockShox IFP Height Tool V2 (Super Deluxe) at the appropriate depth measurement for the corresponding shock model.

**Reservoir Upgrade:** If a Base or Select shock reservoir was upgraded with an Ultimate RC2T reservoir, set the IFP depth to 41 mm.

Model		IFP Depth (mm)
Select R (C1)	Base R (C2)	35
Select+ RT (C1)	Select RT (C2)	
Select+ RCT (C2)		
Ultimate RC2T (C1)	Ultimate RC2T (C2)	41
Ultimate DH (C1)		

**Slowly** push the RockShox IFP Height Tool V2 (Super Deluxe) down into the reservoir to push the IFP down to the appropriate depth. Oil will purge from the damper body bleed port as the IFP Height Tool V2 is pushed down into the reservoir.

The IFP Height Tool V2 will stop when the hex wrench contacts the reservoir.

Remove the RockShox IFP Height Tool V2 (Super Deluxe).

**CAUTION**

The IFP must be set to the specified depth. Failure to set the IFP to the specified depth will result in separation of the reservoir cap from the reservoir when the shock is compressed, which will cause permanent damage to the shock and possible injury to the rider.

**CAUTION - EYE HAZARD**

Do not look directly into the reservoir or damper body bleed port as you push the IFP Height Tool V2 down into the reservoir. Oil may eject from the damper body bleed port and/or RockShox IFP Height Tool V2 (Super Deluxe) if the IFP Height Tool V2 is pushed down too fast. Wear safety glasses.



**22** Remove the shop towel.

Install and tighten the damper body bleed screw into the damper body eyelet.

**WARNING - CRASH HAZARD**

Parts must be tightened to the specified torque. Failure to do so can result in SERIOUS INJURY OR DEATH.

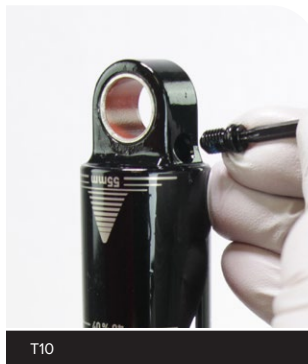

**23** Remove the shock from the vise.

Pour the excess oil out of the IFP reservoir.

Clamp the shock back into the vise.

Wipe away any oil from the damper body and reservoir with a clean shop towel.



**24** To check the bleed quality, insert the RockShox IFP Height Tool V2 (Super Deluxe) back into the IFP reservoir and press down on the IFP applying approximately 25 lbs / 111 N of force.

Remove the RockShox IFP Height Tool V2 (Super Deluxe).

**NOTICE**

Do not push the tool in with more than 25 lbs / 111 N of force. Excess pressure can cause oil to bypass the IFP seal.

The IFP should feel firm and should not compress. If the bleed check window (35 mm or 41 mm IFP height) on the tool is compressed beneath the edge of the reservoir, the system will need to be re-bleed.

To re-bleed the system, the shock must be disassembled and reassembled beginning with [IFP removal](#). Complete all disassembly, reassembly, and bleed procedures before continuing.

**Reservoir Upgrade:** If a Base or Select shock reservoir was upgraded with an Ultimate RC2T reservoir, the IFP depth should be set to 41 mm and the 41 mm bleed check window should be referenced to check bleed quality.

Model		IFP Depth (mm)
Select R (C1)	Base R (C2)	35
Select+ RT (C1)	Select RT (C2)	
Select+ RCT (C2)		41
Ultimate RC2T (C1)	Ultimate RC2T (C2)	
Ultimate DH (C1)		



IFP Height Tool V2



Bleed Check Window

**25** Apply a thin layer of grease to the IFP reservoir cap o-ring. Install the IFP reservoir cap into the reservoir and push it into the reservoir until the retaining ring groove is visible.



RockShox Dynamic Seal Grease

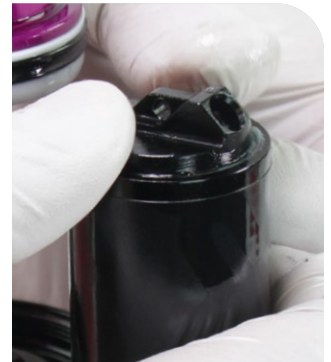

- 26** Insert one end of the retaining ring into the groove.  
Push the retaining ring around the reservoir and into the retaining ring groove until it is completely seated.  
Push the retaining ring in the groove with a pick and confirm the retaining ring is completely seated in the retaining ring groove.

**⚠ CAUTION- EYE HAZARD**

The retention ring can eject rapidly as it is installed. Wear safety glasses.  
To avoid shock failure and possible injury, confirm the retaining ring is completely seated in the retaining ring groove before pressurizing the reservoir.

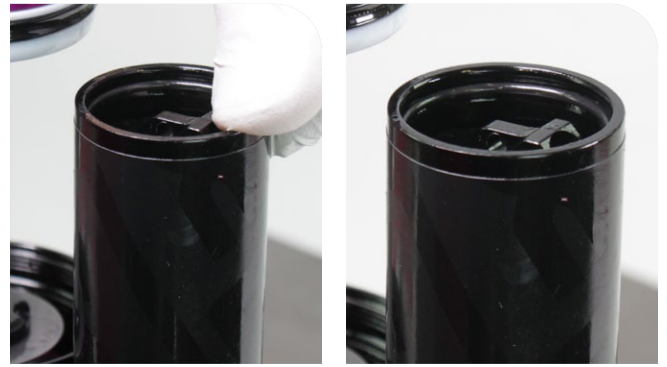
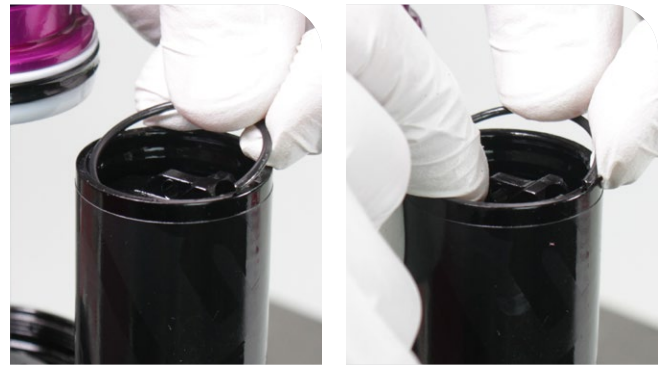

- 27** Pull up on the IFP reservoir cap to seat it against the retaining ring.



Pick (metallic)

- 28** Reinstall the Schrader valve into the IFP reservoir cap.



RockShox Schrader Valve Tool

**29** Install the RockShox rear shock air valve adaptor tool onto the shock pump.

Thread the adaptor tool into the reservoir cap/air valve. Pressurize the reservoir to 200 psi / 13.8 bar.

Unthread adaptor tool from the reservoir cap/air valve with the shock pump still attached.

**NOTICE**

Do not separate the shock pump from the air valve adapter tool. Separating the pump from the adapter first will allow all of the air to escape from the reservoir.

Nitrogen can be substituted if the proper fill equipment is available.



Rear Shock Air Valve Adapter Tool

Shock Pump



200 psi / 13.8 bar



**30** Install a new o-ring onto the reservoir air valve cap.  
Install the air valve cap into the reservoir cap.

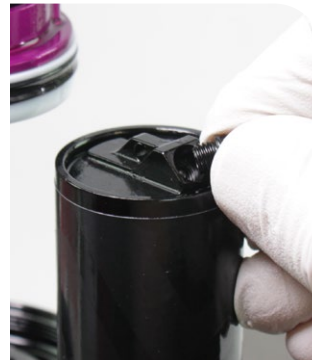

RockShox Schrader Valve Tool

Ultimate RC2T is pictured throughout. All procedures are the same for Select R, Select+ RT, Ultimate RC2T AirWiz, and Ultimate DH RC2 unless otherwise described and/or pictured. All procedures are the same for the Linear XL air can.

Do not remove the AirWiz electronics cover during service. Removal during service can result in permanent damage to the internal electronic components.

**NOTICE**

The MegNeg air can is NOT compatible with 2023+ Super Deluxe (RS-SDLX-BSE-C2, RS-SDLX-SEL-C1, RS-SDLX-SEL-C2, RS-SDLX-SELP-C1, RS-SDLX-SELP-C2, RS-SDLX-ULT-C1, RS-SDLX-ULT-C2, RS-SDLX-ULDH-C1).

- 1** If removed during disassembly, install the negative volume Token.
  - Align the flat inner sections of the negative volume Token with the flat outer sections of the sealhead / air piston. Snap the negative volume Token onto the sealhead / air piston.



- 2** Clamp the shaft eyelet into a vise, with the shock positioned horizontally, and slightly downward.



- 3** Install the Counter Measure onto the damper body.
  - Apply grease to the sealhead / air piston seal.



- 4** Tilt the air can and inject 1 mL of Maxima Extra 15w50 Suspension Oil or Maxima PLUSH Dynamic Suspension Lube Light (half the included pillow pack; 1 pillow pack = 2 mL) into the air can (negative air spring chamber).
  - Rotate the air can and allow the oil to spread evenly around the inner surface of the air can. The oil should pool at the narrow end of the air can at the inner seals and dust wiper seal.

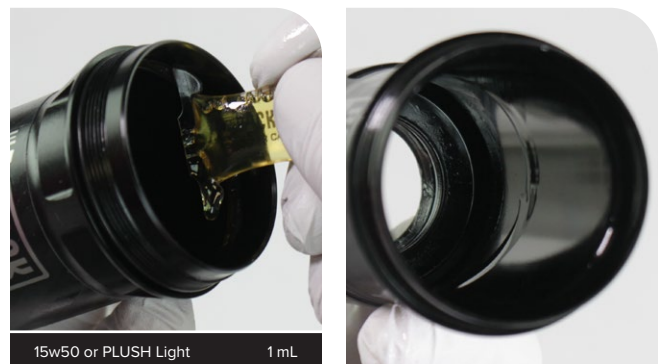

- 5** Install the air can onto the shock over the sealhead / air piston. Engage the seals into the air can and firmly push the air can over the sealhead / air piston toward the eyelet assembly.



- 6** Continue to push the air can toward the eyelet until the end of the damper body protrudes through the air can wiper seal. Stop when there is a gap between the air can and the shaft eyelet assembly.



- 7** Inject another 1 mL of Maxima Extra 15w50 Suspension Oil or Maxima PLUSH Dynamic Suspension Lube Light (remainder of included pillow pack; 1 pillow pack = 2 mL) into the air can (main air spring chamber).



- 8** Firmly push the air can onto the damper until it contacts the eyelet assembly threads. Thread the air can onto the eyelet until it is hand tight.

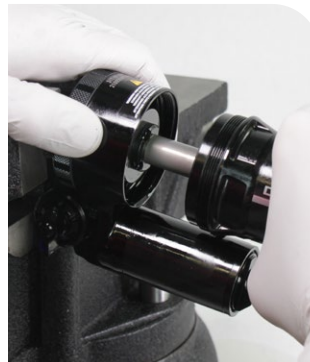

**9** Remove the shock from the vise.

Clamp the damper body eyelet (standard eyelet and bearing eyelet) into the vise with the shock oriented upward.

Spray RockShox Suspension Cleaner onto the shock. Wipe the shock clean and remove any oil and grease.

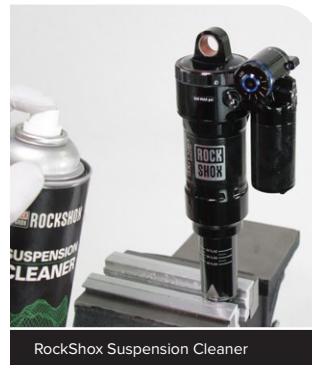

RockShox Suspension Cleaner

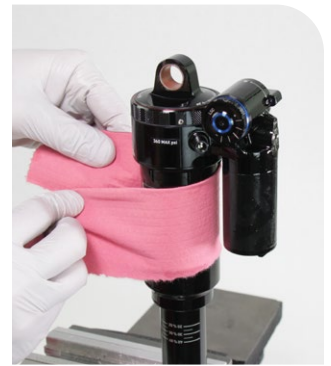

**10** Secure a rubber strap wrench around the air can around the section of the air can furthest from the shaft eyelet (as pictured).

**Linear XL Air Can:** Do NOT secure the rubber strap wrench around the air can sleeve.

**NOTICE**

The air can must be clean and free of grease and oil. Clean the air can if necessary.

To avoid damage to the air can decal, do not place the strap wrench on the air can decal.

While holding the strap wrench firmly to stabilize the shock, tighten the eyelet assembly into the air can. Use the appropriately sized crowfoot for the shock eyelet type.

Eyelet Type	Width (mm)
Standard	13
Bearing	29
Trunnion	54 (Trunnion Crowfoot Tool)

**⚠ WARNING - CRASH HAZARD**

Parts must be tightened to the specified torque. Failure to do so can result in SERIOUS INJURY OR DEATH.



Rubber Strap Wrench



See table

10 N·m (90 in-lb)



Rubber Strap Wrench



See table

10 N·m (90 in-lb)

**11** Install a new sag indicator o-ring.



- 12 Pressurize the shock enough to extend the damper body to full top out, around 50 psi / 3.5 bar.



- For shocks with a Standard Eyelet damper body, go to [Mounting Hardware Installation - Standard Eyelet](#).
- For shocks with a Bearing Eyelet damper body, go to [Damper Body Bearing Eyelet - Installation](#).

## Mounting Hardware - Standard Eyelet

Deluxe is pictured. Procedures are the same for Super Deluxe (Gen C) unless otherwise pictured and/or described.

### NOTICE

To prevent damage to the shock, clamp the shock with vise soft jaws in a vise. Do NOT clamp any part of the shock against steel vise jaws. Before clamping the shock in place in the vise with vise soft jaws, confirm no part of the shock interferes with, or could be damaged by, the vise or the vise soft jaws.

## Mounting Hardware Installation

Some mounting hardware is easily installed using only your fingers. Press the bushing pin into the standard shock eyelet bushing until the pin protrudes from both sides of the eyelet an equal amount. Next, press an end spacer, large outer diameter side first, onto each end of the bushing pin. If this works, you have completed mounting hardware and bushing service.

If you are unable to install your standard eyelet mounting hardware using your fingers, use the RockShox Rear Shock 1/2" x 1/2" Bushing Tool.



- 1 Thread the small end of the push pin (A) onto the threaded rod (B) until the rod protrudes from the hex-shaped end of the push pin.

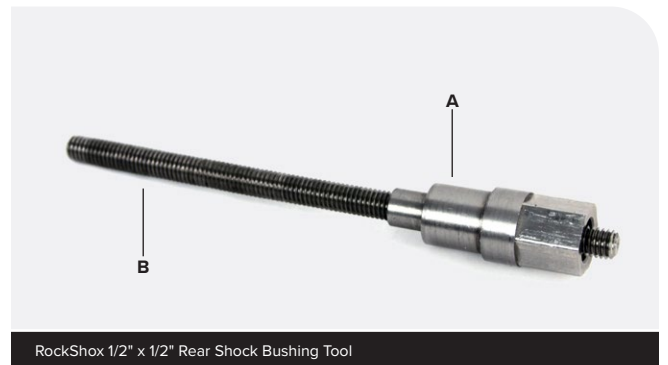

- 2 Insert the pin into the eyelet bushing.



- 3 Insert the threaded rod (A) through the bushing pin, then through the eyelet so that the bushing pin (B) is positioned between the push pin (C) and the eyelet.

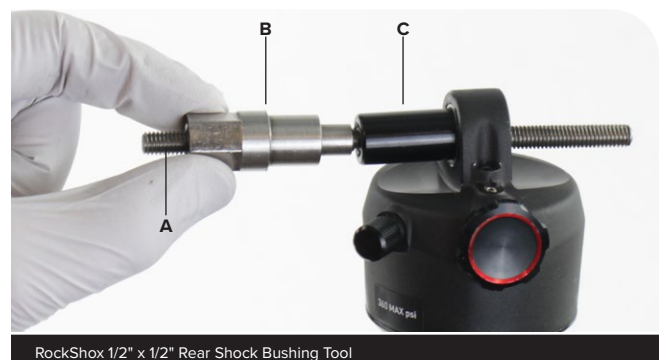

- 4 Thread the large, open end of the catcher (A) onto the threaded rod (B) until the catcher rests on the eyelet.



- 5 Hold the catcher secure with a 13 mm wrench. Use a second 13 mm wrench to thread the push pin along the rod until it pushes the bushing pin into the shock eyelet bushing.

**NOTICE**

Do not damage the shock with the wrenches.

Use one spacer to check the pin position. The pin should be centered in the eyelet.

Continue to thread the push pin until the bushing pin protrudes from both sides of the eyelet an equal amount.

You may need to unthread the catcher slightly to check the bushing pin spacing.

Remove the bushing tool.

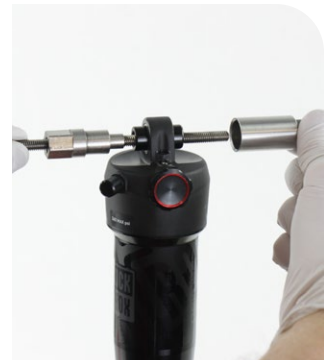
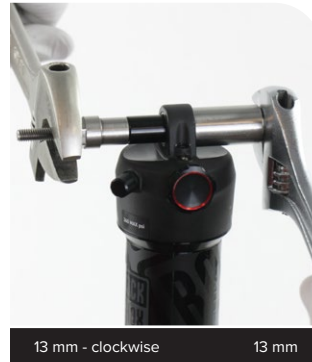

**6** Press an end spacer, tapered side first, onto each end of the bushing pin.

The bushing pin should be centered in the eyelet and no portion of either end should protrude from either end spacer. Re-center the bushing pin if necessary.



## Upgrade (optional) - Standard Eyelet to Bearing Adapter (23 mm)

The RockShox Rear Shock Bearing Adapter is only compatible with a bearing mount frame (30 mm mount width). Confirm compatibility with the frame manufacturer before installation.

The RockShox Rear Shock Bearing Adapter (23 mm) is compatible with the Super Deluxe (Gen C) damper shaft eyelet and damper body eyelet.

The damper body eyelet is pictured. Procedures are the same for the damper shaft eyelet.

A new RockShox Rear Shock Bearing Adapter is pictured. Procedures are the same for an original, previously installed, bearing adapter unless otherwise pictured and/or described.

The [standard eyelet bushing must be removed](#) before the Bearing Adapter can be installed.

### NOTICE

A Super Deluxe (Gen C) with a standard eyelet (damper body eyelet and/or shaft eyelet) is compatible with the 23 mm RockShox Rear Shock Bearing Adapter only. To avoid permanent damage to a Super Deluxe (Gen C) rear shock, do NOT install a 26 mm RockShox Rear Shock Bearing Adapter into the damper body and/or damper shaft standard eyelet.

## Bearing Adapter Installation

Deluxe is pictured. Procedures are the same for Super Deluxe (Gen C) unless otherwise pictured and/or described.

- 1 Remove both bearing covers and set them aside.

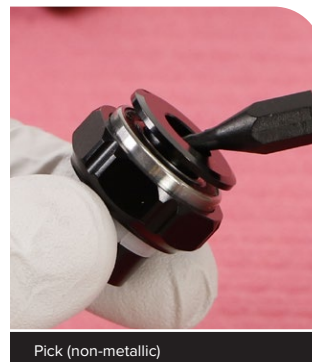
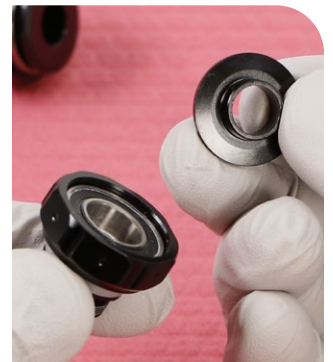

**2** Confirm the crush ring is seated in the groove on the adapter.

Insert the internal threaded bearing adapter (does not include a dimple on each hex flat) into the eyelet and gently press it into the eyelet squarely.

Verify the crush ring is installed in the groove and not pinched between the bearing adapter and the eyelet.

Stop when the crush ring is approximately halfway installed into the eyelet.



**3** Install the external threaded bearing adapter (includes a dimple on each hex flat) into the eyelet and thread it into the internal threaded bearing.

Stop when both crush rings are approximately halfway installed into the eyelet.

Rotate both bearing adapters and confirm the crush rings are in the adapter grooves and the eyelet, and are not pinched between the bearing adapter and the eyelet.

Continue to thread the bearing adapter sides together by hand.

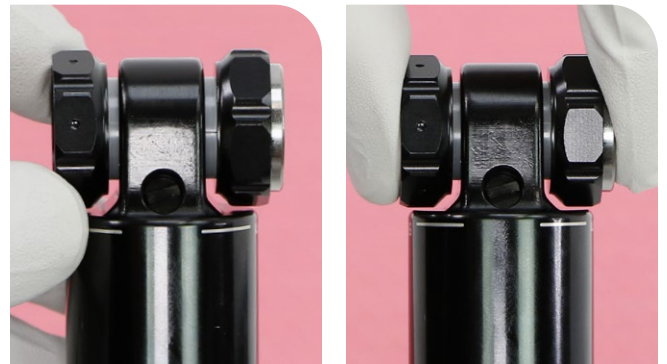
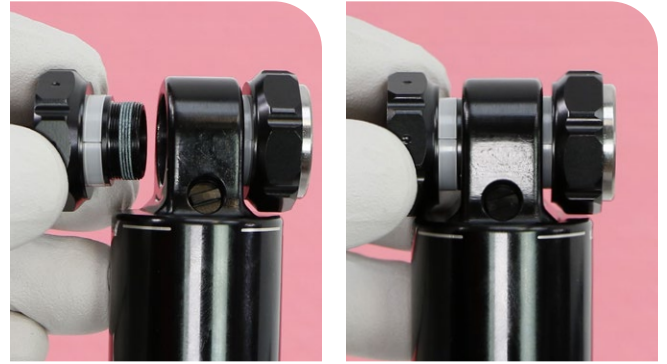

- 4 Clamp one side of the bearing adapter into a vise with soft jaws.

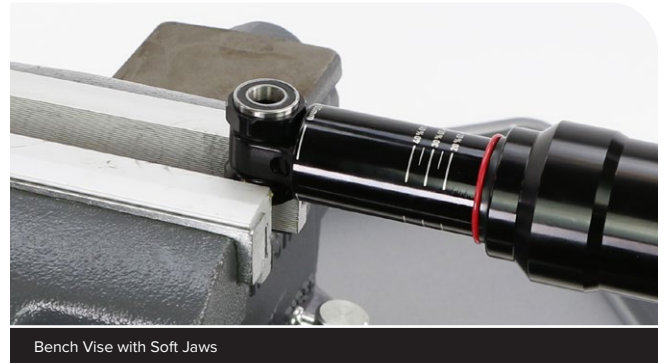

Bench Vise with Soft Jaws

- 5 Tighten the bearing adapter to the specified torque.

**NOTICE**

Do NOT use a standard 22 mm socket to install the RockShox Rear Shock Bearing Adapter. A standard socket may not be compatible. Use ONLY an open end crowfoot or adjustable crowfoot socket.

Do not damage the shock during bearing adapter removal and/or installation.

**⚠ WARNING - CRASH HAZARD**

Parts must be tightened to the specified torque. Failure to do so can result in SERIOUS INJURY OR DEATH.

Remove the shock from the vise.



22 mm - Crowfoot

10 N·m (90 in-lb)



**6** Original Bearing Adapter (if removed before service): Install both bearing covers.

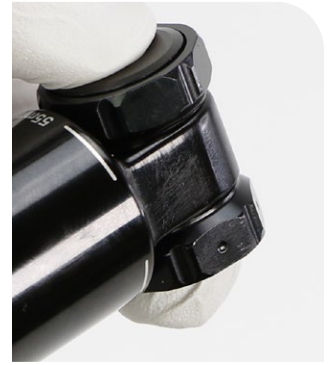
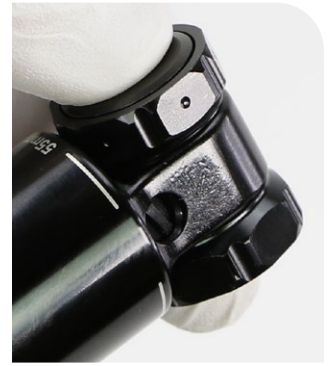

- 7 New Bearing Adapter:** Install both bearing covers and position the bearing adapter in the vise.

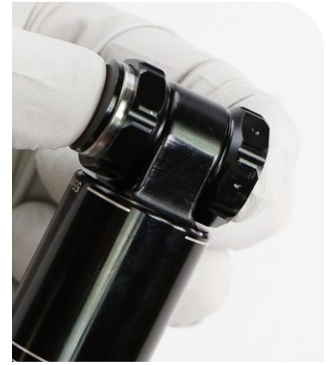
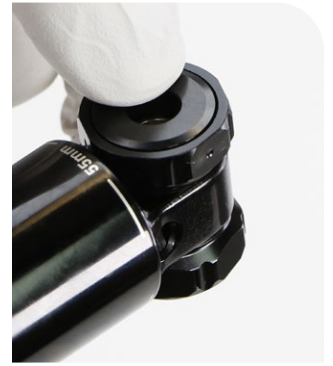
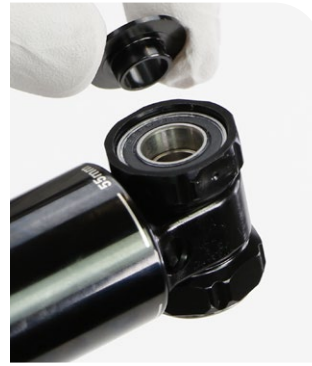

A new Bearing Adapter (23 mm) includes one bearing in the non-dimpled adapter that is not completely seated and must be pressed and seated into the adapter before the shock can be installed onto a bicycle.

Gently close the vise and press the raised bearing into the bearing housing until it stops and the bearing is fully seated into the bearing housing. The bearing cover should also be fully seated in the bearing housing.

### **NOTICE**

Do not overtighten the vise. Overtightening the vise can cause permanent damage to the bearings.



Bench Vise with Soft Jaws



Bench Vise with Soft Jaws



- 8 Measure the total width of the installed RockShox Rear Shock Bearing Adapter, with both bearing covers installed, and confirm the total width is within specification.



If a Bearing Adapter is installed, remove before performing shock service.

## Bearing Eyelet Mount

Replace the bearings if they are not spinning freely, or if they are making a creaking noise.

### Bearing Mount Installation

Install the Bearing Eyelet Mount Assembly after service is complete.

Deluxe is pictured. Procedures are the same for Super Deluxe (Gen C).

#### NOTICE

To prevent damage to the shock, clamp the shock with vise soft jaws in a vise. Do NOT clamp any part of the shock against steel vise jaws. Before clamping the shock in place in the vise with vise soft jaws, confirm no part of the shock interferes with, or could be damaged by, the vise or the vise soft jaws.

- 1 Install the bearing eyelet mount assembly and bolts. Tighten the bolts evenly to the specified torque.

#### ⚠ WARNING - CRASH HAZARD

Parts must be tightened to the specified torque. Failure to do so can result in SERIOUS INJURY OR DEATH.

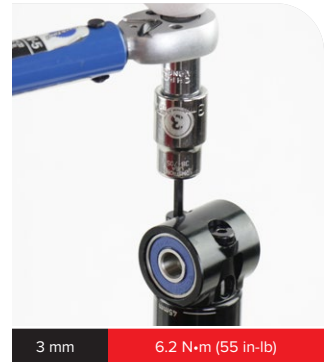

Install the bearing dust covers when the shock is installed back onto the bicycle.



## Shock Installation and Setup

- 1 Reinstall the rear shock as instructed by your frame manufacturer.
- 2 Pressurize the rear shock to the pre-service air pressure written down in the [Record Your Settings](#) table. Refer to the *RockShox Suspension Tuning Guide* for procedures on setting rear shock air pressure and spring sag.
- 3 Adjust the rebound and compression settings to the pre-service settings written down in the [Record Your Settings](#) table.

**This concludes the service for your RockShox rear shock.**



---

ASIAN HEADQUARTERS

SRAM Taiwan  
No. 1598-8 Chung Shan Road  
Shen Kang Hsiang, Taichung City  
Taiwan

WORLD HEADQUARTERS

SRAM, LLC  
1000 W. Fulton Market, 4th Floor  
Chicago, Illinois 60607  
U.S.A.

EUROPEAN HEADQUARTERS

SRAM Europe  
Paasbosweg 14-16  
3862ZS Nijkerk  
Niederlande