

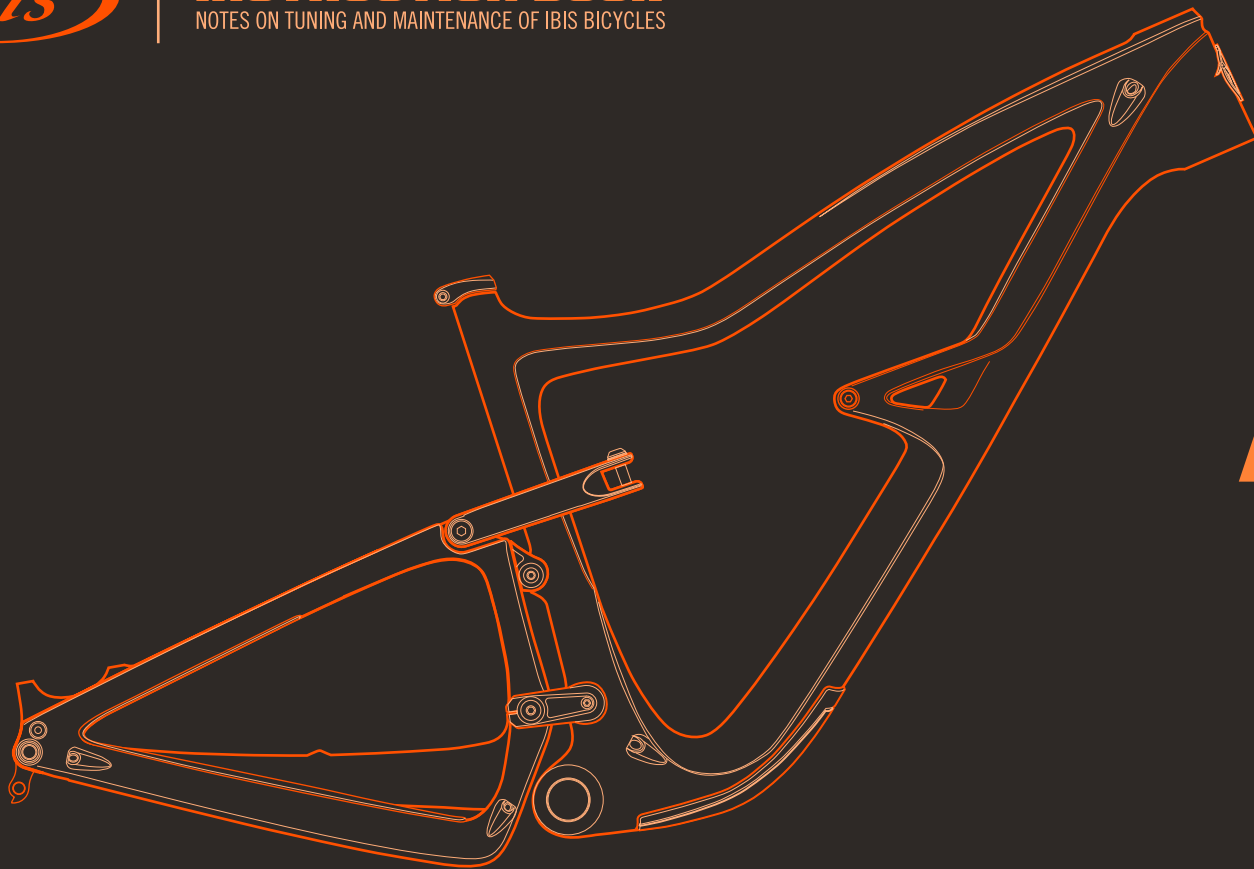

# **INSTRUCTION BOOK**

NOTES ON TUNING AND MAINTENANCE OF IBIS BICYCLES



**REV. J**





***INSTRUCTION MANUAL***

Notes on Tuning and Maintenance of Ibis Bicycles : Rev. J

Reprinting Permitted if Source Quoted

## SALUTATIONS

This Set-Up Guide will help you with assembly tips, get you started on adjusting the suspension, maintaining your frame and explain how to perform basic mechanical jobs.

This guide does not attempt to address full bike assembly, fitting, brake and shifting set-up, riding techniques etc. Please utilize a professional level service for these items to get the best performance and enjoyment from your Ibis.

**This Set-Up Guide is also available online with enhanced functions and additional information:**

[https://www.ibiscycles.com/support/set-up\\_guide](https://www.ibiscycles.com/support/set-up_guide)

**Information on legacy Ibis models available at:**

[http://www.ibiscycles.com/bikes/past\\_models](http://www.ibiscycles.com/bikes/past_models)

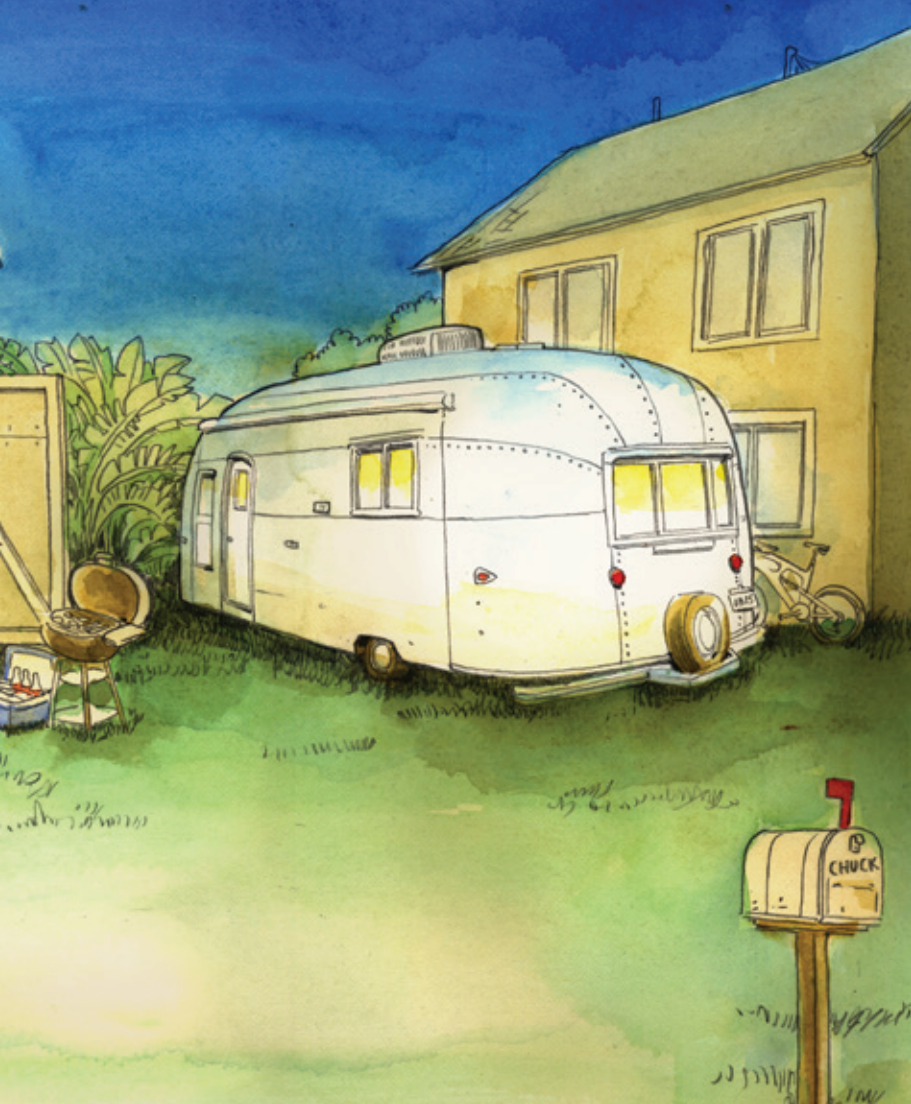

**INTRODUCTION**

2

**BUILD**

Geometry / Quick Specs

4-7

Frame Sizing Guide

8-9

Bike Set-Up Tips and Tricks

10-36

**RIDE**

Fork Set-Up

37-48

Fork Air Pressure Charts

41

Rear Shock Set-Up

52-55

Rear Shock Air Pressure Charts

52

**MAINTAIN**

Bearing/Bushing Maintenance and Replacement

58-59

Frame Hardware

60-64

(Part Numbers and Exploded Views)

Torque Specs

66-67

Swingarm Removal

68-71

**WARRANTY/REGISTRATION**

Warranty

72-73

Serial Number

73

Documentation

73

**EXTRAS**

Chuck's Recipe

74

Contact Info

75

**GEOMETRY / QUICK SPECS**

**RIPMO**

SIZE		SMALL	MEDIUM	LARGE	X-LARGE
SEATTUBE	A	14.5"	14.5"	16.5	18.5"
TOPTUBE	B	573mm	603mm	632mm	655mm
HEADTUBE	C	90mm	100mm	110mm	120mm
CHAINSTAY	D	435mm	435mm	435mm	435mm
SEAT ANGLE	E	77°	76°	76°	76°
HEAD ANGLE	F	64.9°	64.9°	64.9°	64.9°
WHEELBASE	G	1177mm	1195mm	1220mm	1249mm
STACK		613mm	620mm	629mm	642mm
REACH		431mm	446mm	471mm	493mm
STANDOVER		705mm	750mm	750mm	760mm
BB DROP		29mm	29mm	29mm	29mm
SADDLE HEIGHT FOR SEATTUBE ANGLE		650mm	700mm	750mm	800mm

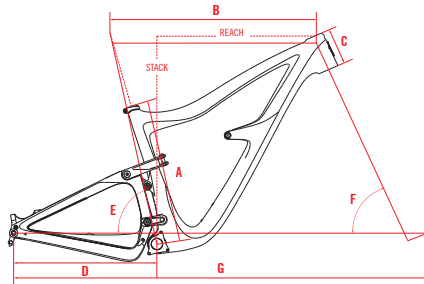

- 29" wheels
- 147mm rear wheel dw-link travel
- Approved for 160mm forks, 44mm rake (STRONGLY recommended)
- 64.9° head angle with a 160mm fork
- Cable routing through continuous internal tubes
- Chainstay length: 17.1"
- Threaded bottom bracket (73mm English thread)
- ISCG 05 compatible with optional removable adapter
- Tapered headtube and steerer: ZS44 upper, ZS56 lower
- 12 x 148mm BOOST rear axle
- 160mm post mount rear brake

**RIPMO AF**

SIZE		SMALL	MEDIUM	LARGE	X-LARGE
SEATTUBE	A	14"	15"	16.5"	18.5"
TOPTUBE	B	573mm	603mm	632mm	655mm
HEADTUBE	C	90mm	100mm	110mm	120mm
CHAINSTAY	D	435mm	435mm	435mm	435mm
SEAT ANGLE	E	77°	76°	76°	76°
HEAD ANGLE	F	64.9°	64.9°	64.9°	64.9°
WHEELBASE	G	1185mm	1216mm	1237mm	1262mm
STACK		613mm	620mm	629mm	642mm
REACH		431mm	458mm	475mm	495mm
STANDOVER		705mm	750mm	750mm	760mm
BB DROP		30mm	30mm	30mm	30mm
SADDLE HEIGHT FOR SEATTUBE ANGLE		650mm	700mm	750mm	810mm

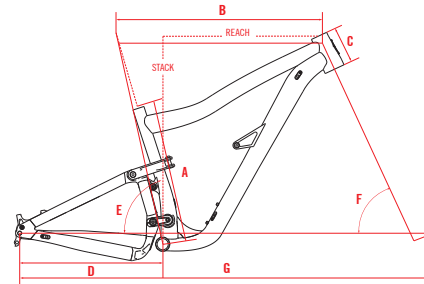

- 29" wheels
- 147mm rear wheel dw-link travel
- Approved for 160mm forks, 44mm rake (STRONGLY recommended)
- 64.9° head angle with a 160mm fork
- Super versatile internal cable routing
- Chainstay length: 17.1"
- Threaded bottom bracket (73mm English thread)
- ISCG 05 compatible with optional removable adapter
- Tapered headtube and steerer: ZS44 upper, ZS56 lower
- 12 x 148mm BOOST rear axle
- 160mm post mount rear brake

## **RIPLEY**

SIZE		SMALL	MEDIUM	LARGE	X-LARGE
SEATTUBE	A	14.5"	15"	16.5"	19"
TOPTUBE	B	574mm	603mm	630mm	658mm
HEADTUBE	C	90	105mm	115mm	125mm
CHAINSTAY	D	432mm	432mm	432mm	432mm
SEAT ANGLE	E	76°	76°	76°	76°
HEAD ANGLE	F	66.5°	66.5°	66.5°	66.5°
WHEELBASE	G	1147mm	1178mm	1207mm	1236mm
STACK		599mm	613mm	622mm	631mm
REACH		425mm	450mm	475mm	500mm
STANDOVER		708mm	712mm	742mm	755mm
BB DROP		38mm	38mm	38mm	38mm
SADDLE HEIGHT FOR SEATTUBE ANGLE		650mm	700mm	750mm	800mm

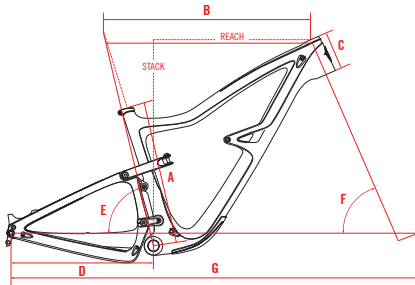

- 29" wheels
- 120mm rear wheel dw-link travel
- Approved for 120-140mm forks, 44mm rake (STRONGLY recommended)
- 66.5° head angle with a 130mm fork
- Cable routing through continuous internal tubes
- Chainstay length: 17"
- Threaded bottom bracket (73mm English thread)
- ISCG 05 compatible with optional removable adapter
- Tapered headtube and steerer: ZS44 upper, ZS56 lower
- 12 x 148mm BOOST rear axle
- 160mm post mount rear brake

## **MOJO HD5**

SIZE		SMALL	MEDIUM	LARGE	X-LARGE
SEATTUBE	A	14"	14.5"	16.5"	18.5"
TOPTUBE	B	582mm	606mm	635mm	669mm
HEADTUBE	C	109mm	126mm	142mm	158mm
CHAINSTAY	D	430mm	430mm	430mm	430mm
SEAT ANGLE	E	76°	76°	76°	76°
HEAD ANGLE	F	64.2°	64.2°	64.2°	64.2°
WHEELBASE	G	1184mm	1211mm	1243mm	1280mm
STACK		595mm	611mm	626mm	640mm
REACH		427mm	447mm	472mm	503mm
STANDOVER		696mm	710mm	731mm	750mm
BB DROP		7mm	7mm	7mm	7mm
SADDLE HEIGHT FOR SEATTUBE ANGLE		640mm	690mm	760mm	810mm

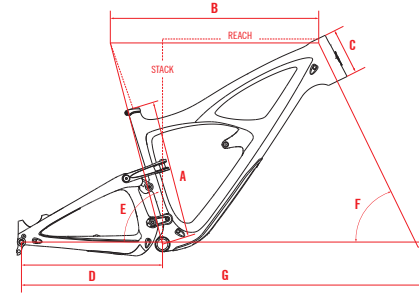

- 650b (27.5") wheels
- 153mm rear wheel dw-link travel
- Approved for 160-170mm forks, 37mm rake (STRONGLY recommended)
- 64.2° head angle with a 170mm fork
- Cable routing through continuous internal tubes
- Chainstay length: 16.9"
- Threaded bottom bracket (73mm English thread)
- ISCG 05 compatible with removable adapter
- Tapered headtube and steerer, ZS44 upper, ZS56 lower
- 12 x 148mm BOOST rear axle
- 180mm post mount rear brake

## GEOMETRY / QUICK SPECS

## MOJO 3

SIZE		SMALL	MEDIUM	LARGE	X-LARGE
SEATTUBE	A	14.4"	16.9"	18.7"	20.5"
TOPTUBE	B	580mm	600mm	620mm	640mm
HEADTUBE	C	85mm	105mm	117mm	132mm
CHAINSTAY	D	425mm	425mm	425mm	425mm
SEAT ANGLE	E	74.6°	73.6°	73.6°	73.6°
HEAD ANGLE	F	66.8°	66.8°	66.8°	66.8°
WHEELBASE	G	1126mm	1137mm	1158mm	1180mm
STACK		578mm	592mm	602mm	616mm
REACH		419mm	423mm	438mm	455mm
STANDOVER		676mm	712mm	724mm	754mm
BB DROP		21mm	21mm	21mm	21mm
SADDLE HEIGHT FOR SEATTUBE ANGLE		600mm	720mm	787mm	807mm

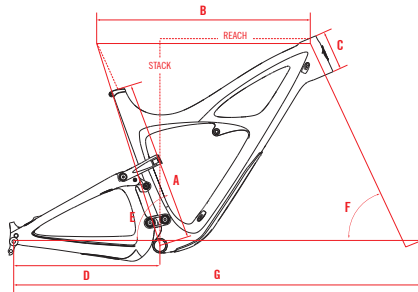

- 650b (27.5") wheels
- 130mm rear wheel dw-link travel
- Best with 140mm forks
- 66.8° head angle with a 140mm fork
- Super versatile internal cable routing
- Chainstay length: 16.7"
- Threaded bottom bracket (68mm English thread)
- ISCG 05 compatible with optional removable adapter
- Tapered headtube and steerer, ZS44 upper, ZS56 lower
- 12 x 148mm BOOST rear axle
- 160mm post mount rear brake

## DV9

SIZE		SMALL	MEDIUM	LARGE	X-LARGE
SEATTUBE	A	14.5"	17"	19"	21"
TOPTUBE	B	582mm	607mm	628mm	658mm
HEADTUBE	C	92mm	110mm	116mm	133mm
CHAINSTAY	D	439mm	439mm	439mm	439mm
SEAT ANGLE	E	73°	73°	73°	73°
HEAD ANGLE	F	68.5°	68.5°	68.5°	68.5°
WHEELBASE	G	1100mm	1126mm	1147mm	1182mm
STACK		611mm	628mm	634mm	649mm
REACH		397mm	418mm	435mm	462mm
STANDOVER		687mm	757mm	757mm	782mm
BB DROP		64mm	64mm	64mm	64mm

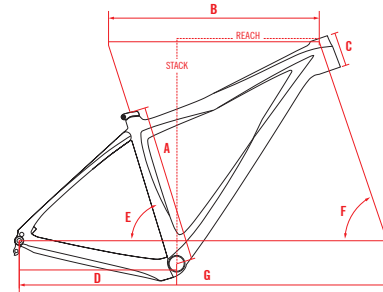

- 29" wheels
- Approved for 100-120mm forks, 51mm rake (STRONGLY recommended)
- 68.5° head angle with a 100mm fork
- 67.4° head angle with a 120mm fork
- Super versatile internal cable routing
- Chainstay length: 17.3"
- Threaded bottom bracket (68mm English thread)
- Tapered headtube and steerer: ZS44 upper, EC49 lower
- 12 x 148mm BOOST rear axle
- 160mm post mount rear brake

# HAKKA MX

SIZE		49	53	55	58	61
SEATTUBE	A	455mm	525mm	550mm	575mm	605mm
TOPTUBE	B	520mm	540mm	550mm	570mm	590mm
HEADTUBE	C	110mm	135mm	155mm	175mm	195mm
CHAINSTAY	D	430mm	430mm	430mm	430mm	430mm
SEAT ANGLE	E	74.5°	73.5°	73.5°	73.5°	73.5°
HEAD ANGLE	F	70.5°	71.5°	72°	72°	72°
WHEELBASE	G	1007mm	1011mm	1021mm	1037mm	1057mm
STACK		532mm	560mm	580mm	599mm	616mm
REACH		370mm	373mm	382mm	391mm	406mm
STANDOVER		729mm	785mm	802mm	827mm	853mm
BB DROP		70mm	70mm	70mm	70mm	70mm

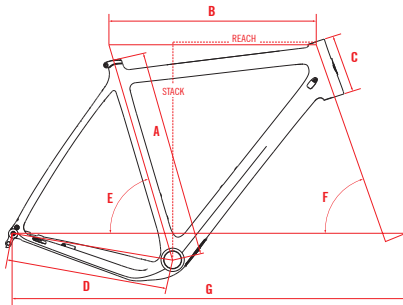

- 700c or 650b (27.5") wheels
- Trail: 67mm @ 71.5° head angle, 70mm @ 71° and 73mm @ 70.5°
- Super versatile internal cable routing, Di2 compatible
- T47 bottom bracket (68mm shell width)
- 700x40c BB Height: 283mm
- 700x33c or 27.5x2.1" BB Height: 277mm
- 34.9mm bottom pull front derailleur
- Tapered headtube: IS41 upper, IS52 lower
- 142x12mm rear dropout spacing
- 140mm flat mount rear (160mm max rotor)

**FRAME SIZING GUIDE****MOUNTAIN BIKE SIZING GUIDE**

FRAME SIZE	HEIGHT / IN	HEIGHT / CM
SMALL	5'0" – 5'5"	152 – 165
MEDIUM	5'4" – 5'9"	163 – 175
LARGE	5'8" – 6'1"	173 – 186
X-LARGE	6'0" – 6'6"	183 – 198



**HAKKA MX SIZING GUIDE**

FRAME SIZE	HEIGHT / IN	HEIGHT / CM
49	5'0" – 5'4"	152 – 163
53	5'3" – 5'8"	160 – 173
55	5'7" – 5'11"	170 – 180
58	5'10" – 6'2"	178 – 188
61	6'1" – 6'6"	185 – 198



**BIKE SET-UP TIPS AND TRICKS****RIPMO/RIPMO AF/RIPLEY/HD5***Driveside Cable Routing*

For cable routing, the Ripmo / Ripley / HD5 features carbon fiber tubes molded inside the frame.

Just push the housing through and it pops out the other end. Simple! And quiet too.

The Ripmo AF cables are routed similarly but there are no tunnels and use our versatile cable ports.

**RIPMO / RIPMO AF / RIPLEY / HD5**  
Non-Driveside Cable Routing

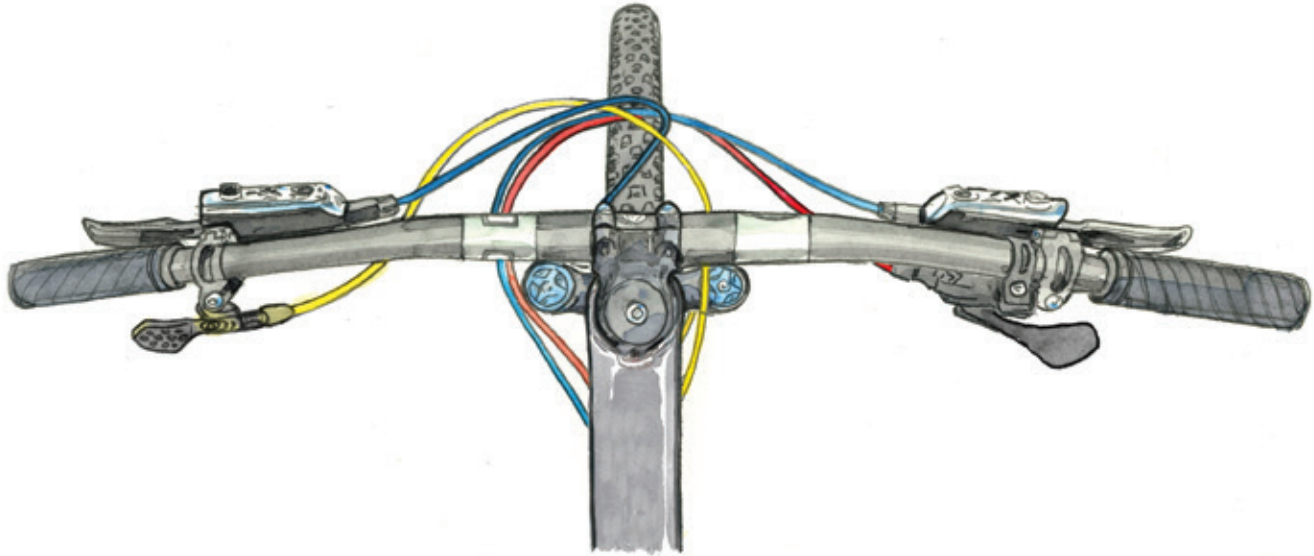

**IMPORTANT:** Before riding the Ripmo / Ripmo AF, check the saddle to tire clearance with the dropper post fully dropped and the air out of the shock with frame compressed to bottom out.

**BIKE SET-UP TIPS AND TRICKS****RIPMO/RIPMO AF/RIPLEY/HD5***1x Cable Routing*

**NOTE:** On bikes with the cable routed through the carbon tunnels, we recommend using grease on the cable housing prior to installation in the tunnels.

**RIPMO / RIPMO AF / RIPLEY / HD5**  
Front Cable Routing

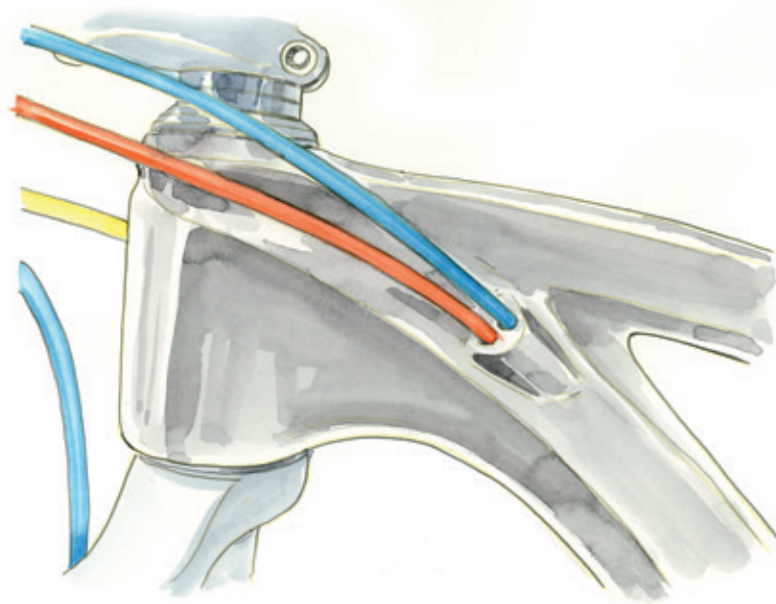

**NOTE:** The Ripmo AF uses our cable ports in this location. In order to keep the internal cables from rattling inside the down tube of the Ripmo AF, we recommend the following: As you are inserting the cables into the down tube, attach several zip ties leaving the tails long and orienting each tail in a different direction. This will keep the cable housing from making noise inside the down tube under rough riding conditions.

**BIKE SET-UP TIPS AND TRICKS****RIPMO/RIPMO AF/RIPLEY/HD5**

*Driveside Cable Routing*

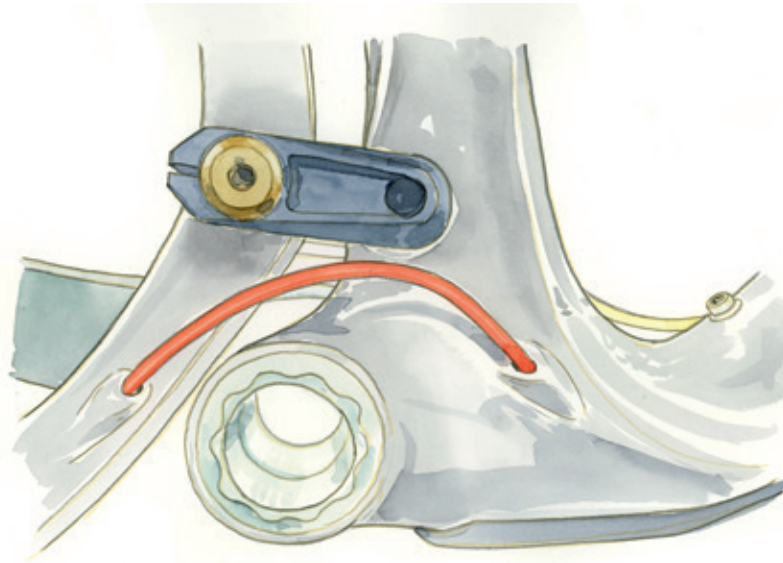

**NOTE:** The Ripmo AF uses a cable port to exit the down tube, then you run uninterrupted cable to the rear derailleur, from the front of the chainstay and exiting via the port at the end of the chainstay.

**RIPMO / RIPMO AF / RIPLEY / HD5**  
Non-Driveside Cable Routing

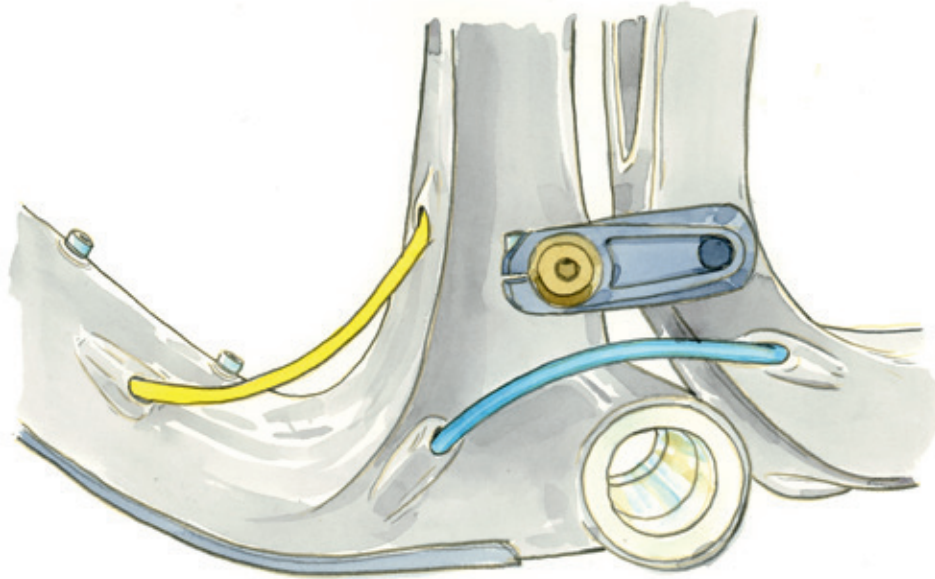

**NOTE:** The Ripmo AF uses a hydro cable port to exit the down tube, then you run the brake line on top of the chainstay back to the caliper.

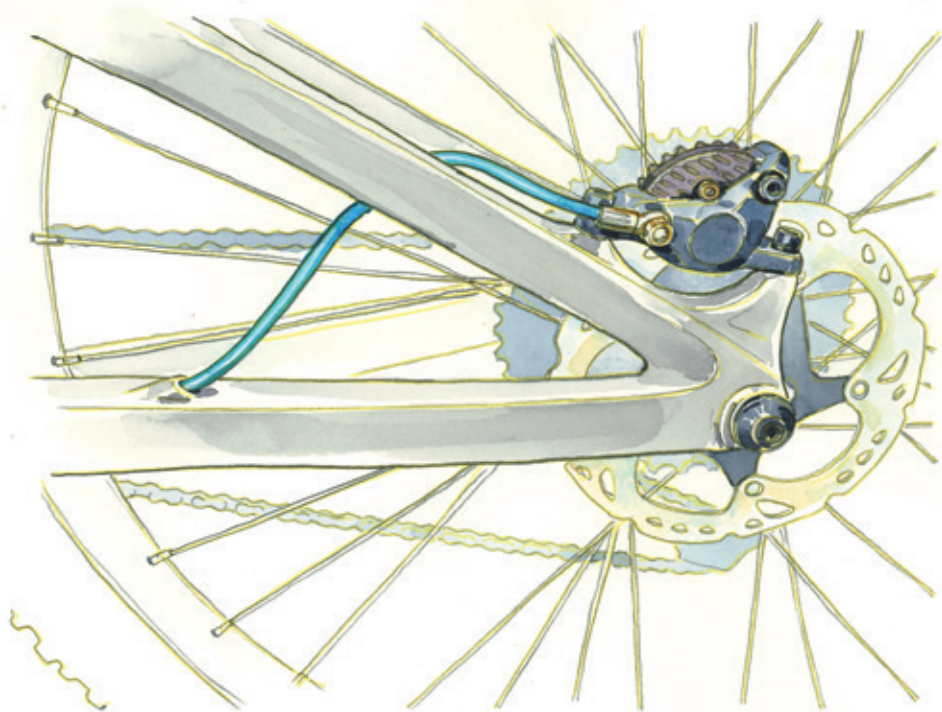
**BIKE SET-UP TIPS AND TRICKS****RIPMO/RIPMO AF/RIPLEY/HD5***Brake Cable Routing*

### **MOJO HD5 AND RIPMO/RIPMO AF/RIPLEY CHAIN GUIDE**

For the Ripmo, Ripmo AF, Ripley, Mojo HD5, and Mojo 3 we manufacture an optional, removable ISCG 05 mount which mounts on the splines on the drive side of the bottom bracket. Standard procedures apply to mounting an ISCG 05 compatible chain guide or bash guard.

**If you need an ISCG 05 adapter, it's available in our online store:**

<http://store.ibiscycles.com> and search **ISCG**.

### **CHAIN LENGTH**

To determine the correct chain length: shift into the large chainring and largest cog and let all the air out of your shock (on suspension bikes only, duh).

Thread the chain through the gears and derailleurs, compress the suspension all the way to bottom out, and cut the chain at the minimum length needed with the rear derailleur stretched out.

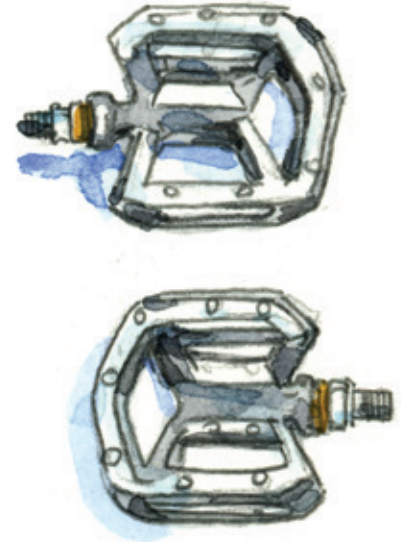

**BIKE SET-UP TIPS AND TRICKS****MOJO 3**  
*Driveside Cable Routing*

The Mojo 3 uses our versatile cable port system for cable routing. We have several port styles available, depending on your drivetrain and dropper configuration.

**MOJO 3***Non-Driveside Cable Routing*

The most common set-up these days is a 1X drivetrain with an internally mounted dropper. We spec the Bike Yoke Revive or KS E30i, depending on the group. We recommend you run your brake on the exterior, along the left side of the down tube.

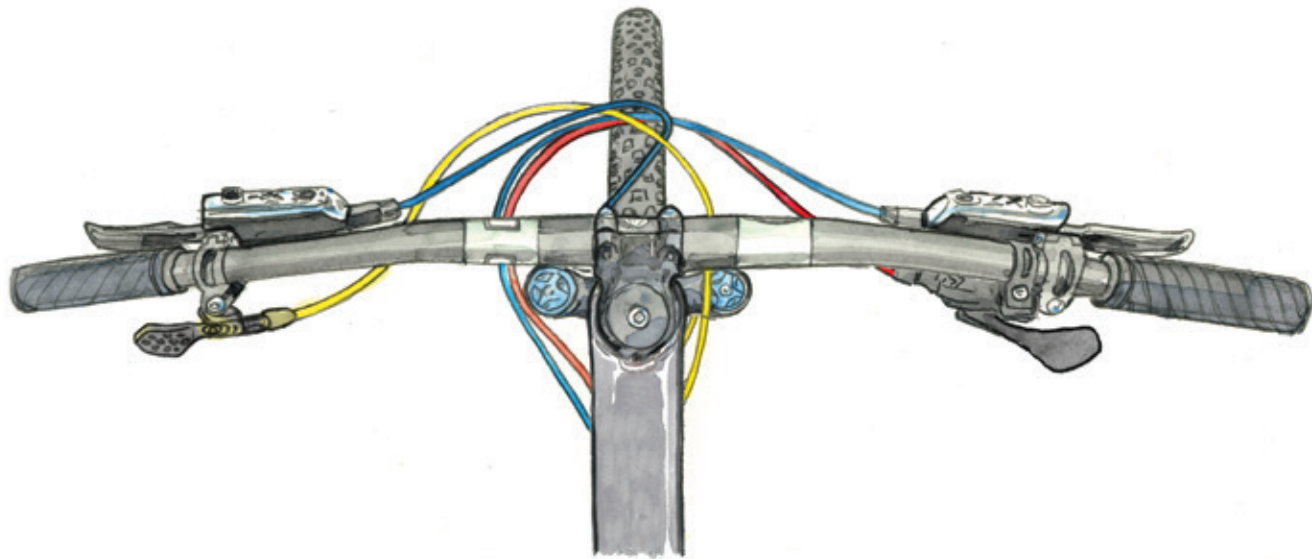
**BIKE SET-UP TIPS AND TRICKS****MOJO 3**  
*1x Cable Routing*

**MOJO 3**  
Derailleur Cable Routing

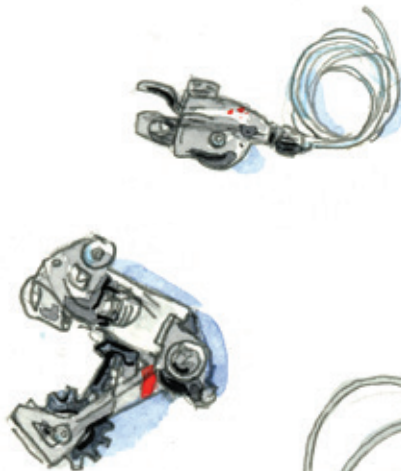
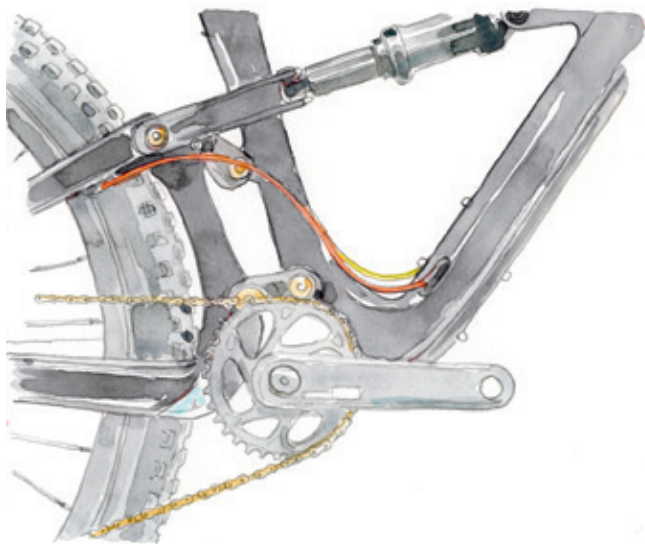



**MOJO 3**  
*Brake Cable Routing*

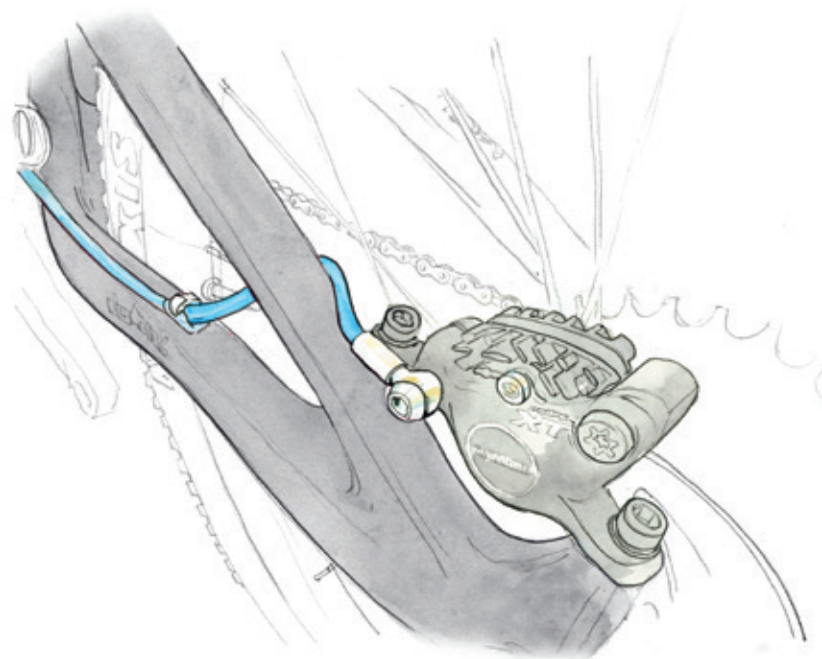

**BIKE SET-UP TIPS AND TRICKS****DV9***Driveside Cable Routing*

**DV9**  
*Non-Driveside Cable Routing*

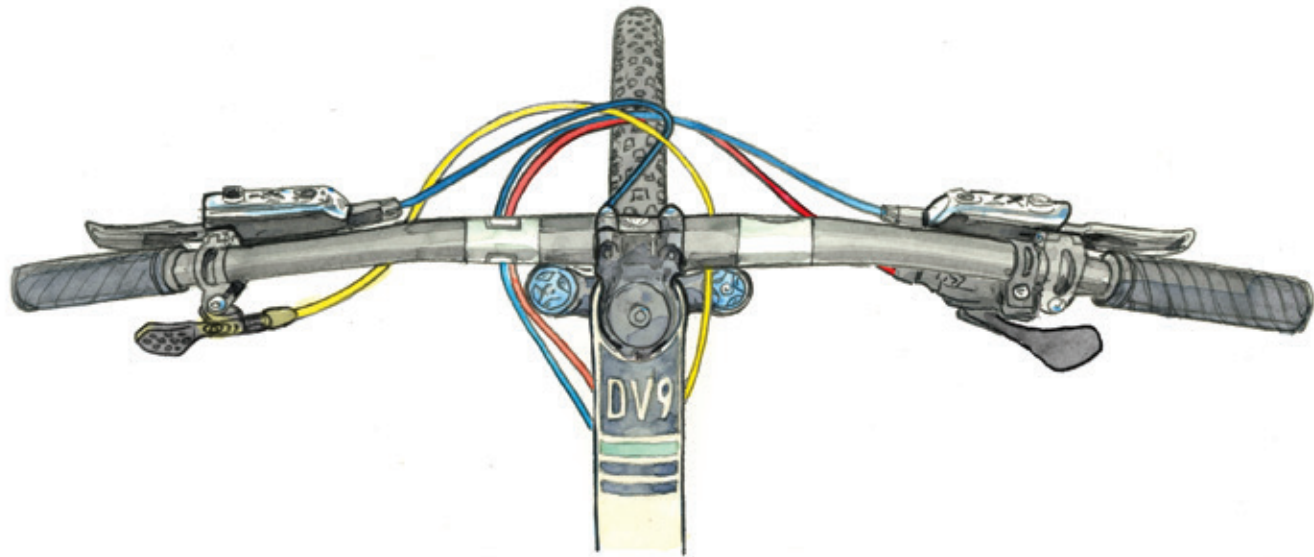

**BIKE SET-UP TIPS AND TRICKS****DV9***1x Cable Routing*

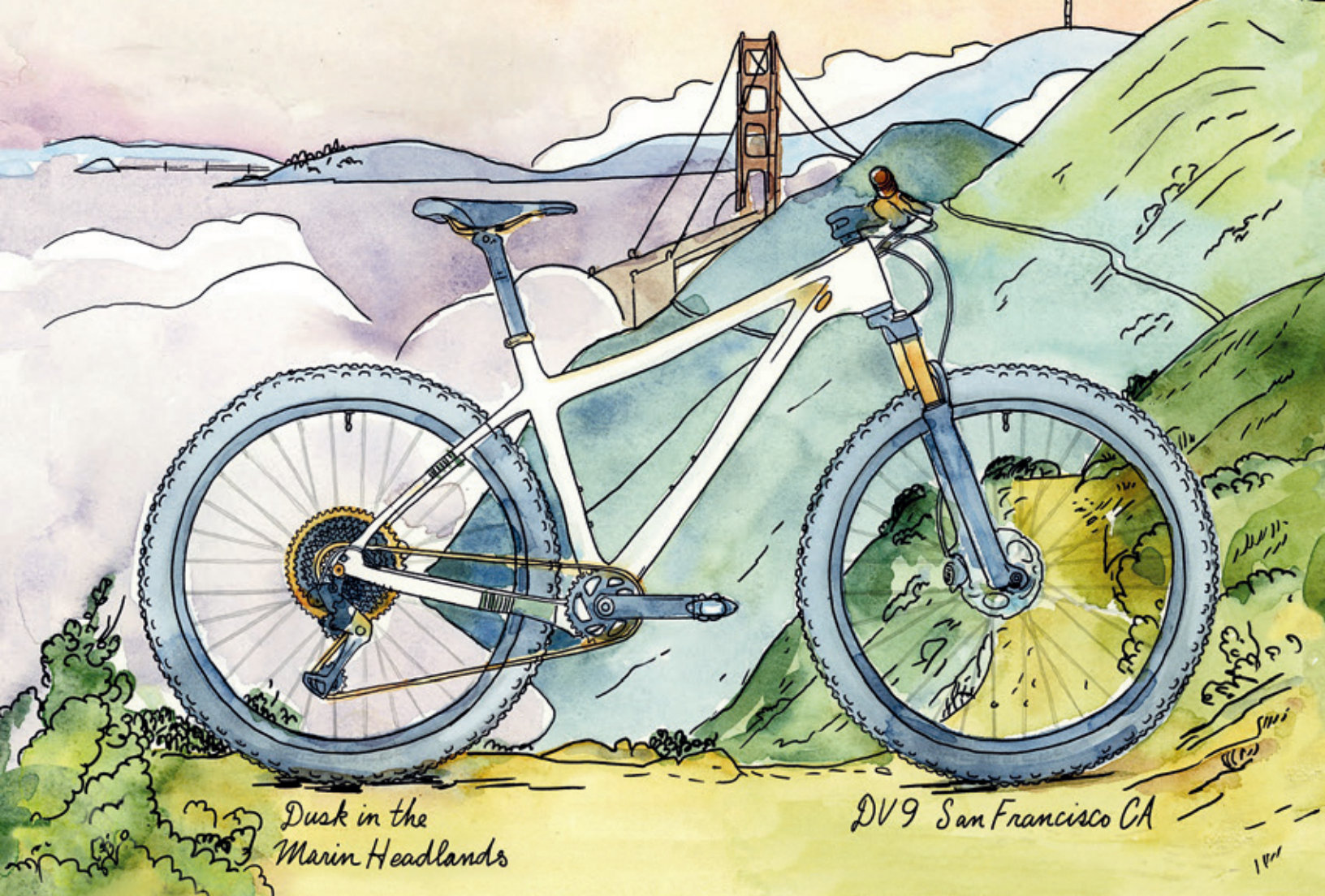

Dusk in the  
Marin Headlands

DV9 San Francisco CA

1/11

## BIKE SET-UP TIPS AND TRICKS

### HOW TO ROUTE THE HAKKA MX FRONT DERAILLEUR CABLE THROUGH THE BOTTOM BRACKET

- The bike came with a noodle (in the bag of stuff), you'll need that.
- Feed a shift wire (an old one) through the noodle so the the cable nub is stuck in the open end (where housing would fit in)
- Feed the bare end of the cable through the cable stop from the inside so that it exits out the frame along the seat tube. This is the trickiest part, it helps to put a little kink in the end of the cable
- Pull the cable all the way out the port so that it is pulling the cable noodle into the cable stop. Use a fourth hand tool to pull on the cable and massage the noodle so that it is firmly placed in the cable stop (should be a snug fit). Once it is in place in the cable stop, leave it there!
- Once the noodle is in the cable stop, remove the cable and route your cable housing from the front shifter to the noodle (internal to the down tube). The end of the noodle should be accessible from the bolt-on door underneath the down tube.
- Feed your shift cable from the shifter, through your housing, into the noodle, and out to the front derailleur. If the cable catches on the cable stop upon exiting the noodle, it may help to add a kink to the end of the cable.

### CAN I PUT A FOX AX FORK ON MY HAKKA?

The Fox AX fork will only fit on the 55cm frame. It will touch the down tube on all other frame sizes. It also impacts the geometry in a negative manner, making the angles too slack. In other words, we do not recommend it.

### CAN I PUT A REAR RACK ON MY HAKKA MX?

The Hakka MX is not rear rack compatible. The eyelets on the stays are for fenders. The seat stays are not designed to withstand the forces of a rack. For bikepacking, we recommend something similar to the illustration over to the right.

### BB DRAIN ON HAKKA

The Hakka MX is intended to have a small hole drilled in the bottom of the bottom bracket shell. Some of them don't, and if you ride in wet conditions, water could accumulate in your bottom bracket. It's simple to check, just look under your bottom bracket shell. If there's no hole, simply use a 2mm or thereabouts drill and gently drill through the aluminum shell.

### HAKKA MX Di2 CABLING INSTRUCTIONS

Here's what each wire length is intended to connect:

**1200mm:** Connects A junction box (at stem) to B junction box (inside down tube)

**900mm:** Connects B junction box to rear derailleur (routes through right chainstay)

**2x400mm:** connects right and left shifters to A junction box. The left shifter is not necessary, but we include it anyway in case you want right-up/left-down type shifting

**350mm:** Connects battery (zip-tied to down tube battery door) to B junction box.

Try to attach the B junction box to the battery so that it isn't rattling loose inside the down tube. Another option would be to wrap it in foam so that it doesn't make any sound as it bounces around.

Here's how you mount the battery to the battery door.

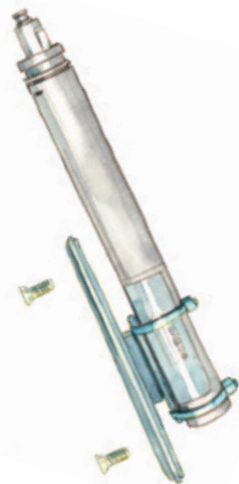

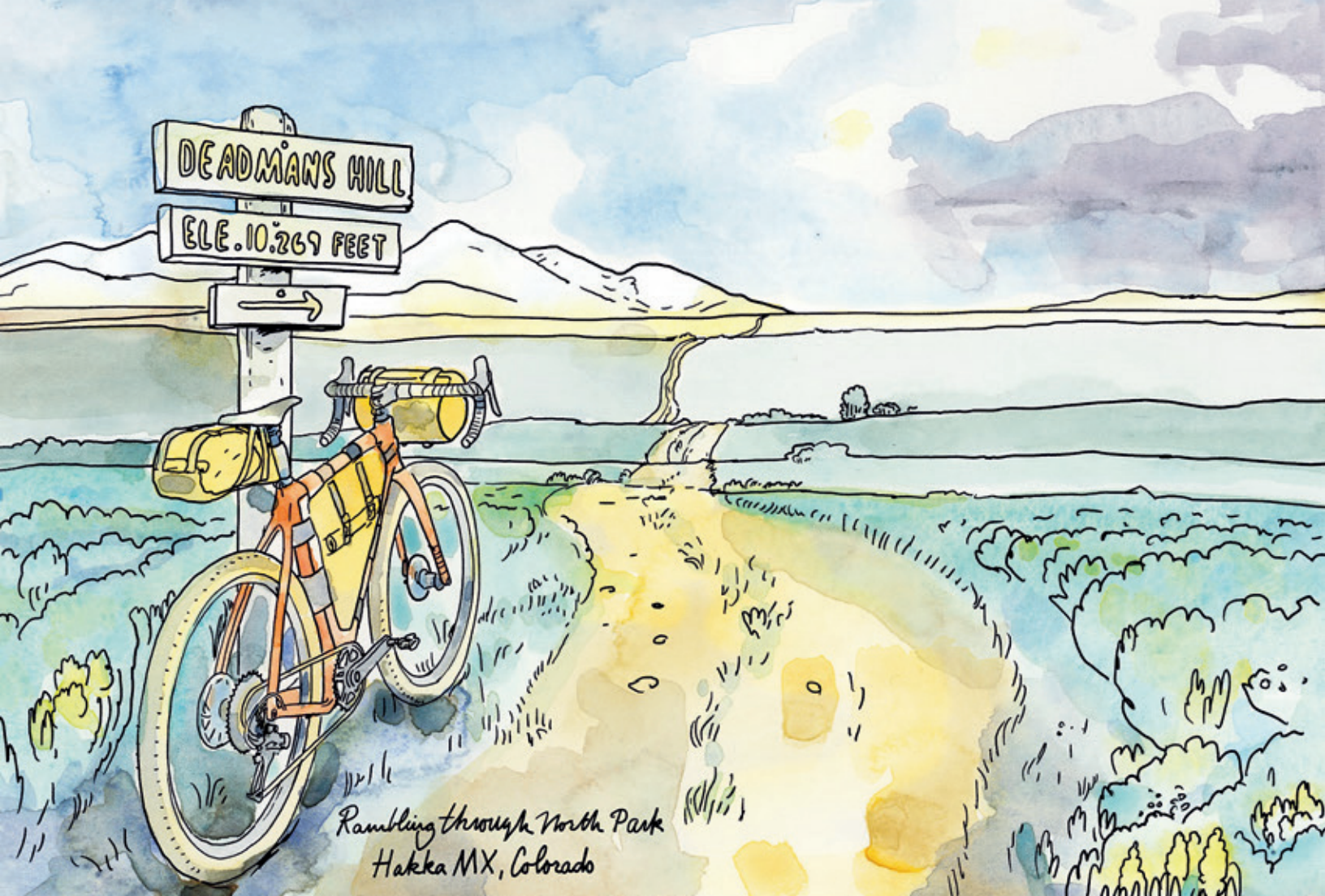

DEADMANS HILL

ELE. 10,269 FEET



*Rambling through North Park  
Hakka MX, Colorado*

**BIKE SET-UP TIPS AND TRICKS**

**CABLE ROUTING PORTS**

On all bikes except the Ripmo, Ripley and HD5, we now have plastic ports that play nicer with your cable housing. They include the most popular ones: single stop and single port, double port and double port/stop. Parts that will remain metal are single blank, single Di2, double Di2, and single Reverb port.



There are dozens of possible port/routing combinations on our bikes. For the latest port availability, go to our online store and search for **port**: <http://store.ibiscycles.com>



**MOTO FRONT BRAKE ROUTING**

**HD5/RIPLEY/RIPMO/RIPMO AF**

Put the rear brake in the dropper hole (right side of down tube) and the dropper in the brake hole (left side). They both come out on the same side of the BB so you can plug them in to their correct segments after that.

**MOJO 3/DV9**

We recommend you route the rear brake line directly from the lever on the left-hand side of the handlebar to the left side of the down tube, attaching it using existing guides. The line will have a slightly tighter radius than it would otherwise but that is OK. Be sure to leave sufficient line so the handlebars can rotate in the event of a crash. If necessary, use clear adhesive dots to prevent the line rubbing on the headtube.

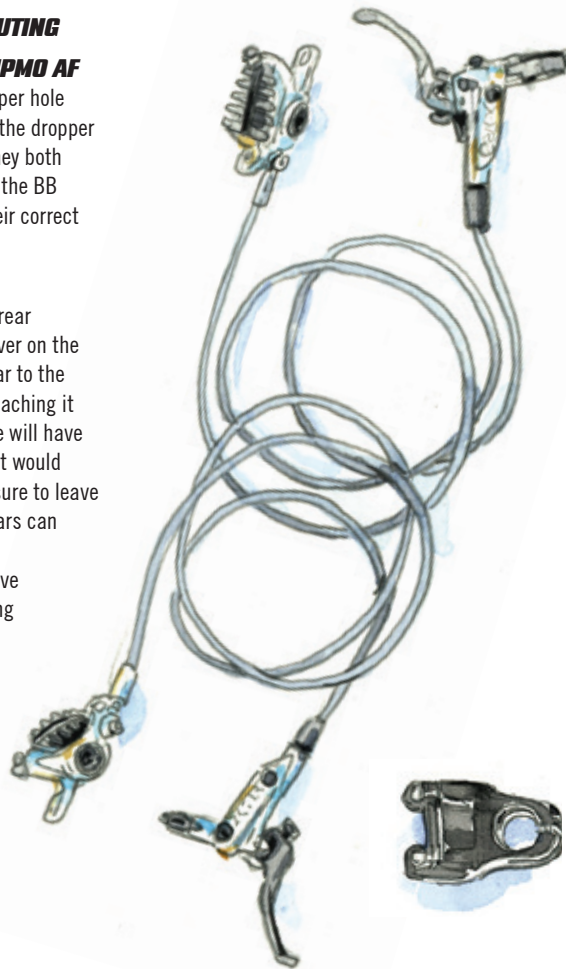



## BIKE SET-UP TIPS AND TRICKS

### NOTE ON BOOST MOJO HD5/MOJO 3 BOTTOM BRACKET INSTALLATION

The profile of the carbon swingarm on the Mojo HD5 and Mojo 3 rear triangle is wider so it interferes with the bottom bracket (BB) tool when the swingarm is in the top out position.

The BB cup on the non-drive side of the rear triangle is very close to the swingarm. When installing the BB care should be given to not scratch up or otherwise damage the frame.

We recommend using only a socket type BB installation tool from your preferred bike tool manufacturer.

On the Mojo 3, you can gain some extra room by deflating the shock and moving the swingarm to the bottom out position.

YES



NO



### WIDE RIMS

In 2014, we introduced our line of wide carbon fiber rims and wheels.

Wide rims support the tire's sidewalls better, allowing lower pressures without the tires folding over or burping. This dramatically increases stability and traction. This shows up as faster cornering and braking, better grip in all conditions.

The low system weight of the wheels with these rims and tires combined with the monstrous traction advantage have been a revelation for those who have ridden them.

Our carbon wheels can now be ordered with the excellent Industry Nine Hydra hubs. The durable hubs are made in the USA in Industry Nine's Asheville machine shop with an incredible .52° engagement. They are equipped with Enduro bearings and come with either Shimano Microspline or SRAM XD drivers.

You can read all about our new rim and wheel technology at:

<http://www.ibiscycles.com/wheels/>

### PLUS TIRES

If you take a straw poll of the folks at Ibis, we've settled on 2.6" as being the sweet spot for overall performance and traction in the 27.5 and 29" wheel platforms.

The Mojo 3 is compatible with tires up to 2.8". Either of these tire sizes combined with our ultra

wide aluminum and carbon fiber rims provide elbow-dragging traction. Which is good.

The new S35 (and previous generation 742 / 942 / 738 / 938) rims are ideal for the ultra low pressures (10-18 psi) that we like to run with 2.6 and 2.8 Plus tires (or 18-25psi for 2.25 - 2.5 tires). Any of our 35mm internal width rims work incredibly well with the new wide rim friendly rubber we've been riding from Schwalbe, Maxxis and others.

### SETTING PRESSURES ON THE IBIS WIDE RIMS

Pressures should range between 15 and 30 Psi depending on rider weight, tire size and terrain. Use more pressure in rockier terrain.



## BIKE SET-UP TIPS AND TRICKS

	CARBON i9				CARBON LOGO				
RIMS & WHEELSETS	S35 / 27.5	S28 / 27.5	S35 / 29	S28 / 29	S35 / 27.5	S28 / 27.5	S35 / 29	S28 / 29	D30
WHEEL SIZE	27.5"	27.5"	29"	29"	27.5"	27.5"	29"	29"	700
OUTER WIDTH (MM)	41	35	41	35	41	35	41	35	26
INNER WIDTH (MM)	35	28.6	35	28.6	35	28.6	35	28.6	19
RIM WEIGHT (G)	420	380	455	410	420	380	455	410	400
RIM MATERIAL	Toughened Hybrid Carbon				Toughened Hybrid Carbon				Carbon
DRILLING	32°				32°				24°
TYPE	Tubeless				Tubeless				Tubeless
WHEELSET WEIGHT (G)	1600	1530	1650	1580	1640	1570	1710	1630	1504
SECTION HEIGHT	18.3	18.3	18.3	18.3	18.3	18.3	18.3	18.3	30
SPOKE OFFSET (MM)	5	4	5	4	5	4	5	4	0
SPOKES	Sapim CX-Ray				Sapim D-Light				Sapim D-Light
CROSS	3				3				2
SPOKE LENGTH (MM)**	Front: 276ND / 275D, Rear: 275ND / 273D		Front: 296ND / 294D, Rear: 294ND / 292D		274	275	293	293	Front: 280ND / 278D, Rear: 278ND / 280D
ERD (MM)	566	564	604	602	566	564	604	602	583
THRU AXLE OPTIONS	15x110 / 148x12				15x110 / 148x12	15x110 / 148x12 12x100 / 142x12	15x110 / 148x12		12x100 / 142x12
MAX RIM PRESSURE	40				40				23mm: 120psi, 32mm: 80psi, 40mm: 70psi
FEATURES	5mm Asymmetric High Impact Carbon Stan's BST Mounting	4mm Asymmetric High Impact Carbon Stan's BST Mounting	5mm Asymmetric High Impact Carbon Stan's BST Mounting	4mm Asymmetric High Impact Carbon Stan's BST Mounting	5mm Asymmetric High Impact Carbon Stan's BST Mounting	4mm Asymmetric High Impact Carbon Stan's BST Mounting	5mm Asymmetric High Impact Carbon Stan's BST Mounting	4mm Asymmetric High Impact Carbon Stan's BST Mounting	Readily Accepts Tires from 23c to 42c
HUBS	S35 / 27.5	S28 / 27.5	S35 / 29	S28 / 29	S35 / 27.5	S28 / 27.5	S35 / 29	S28 / 29	D30
BRAND	Industry Nine Hydra				Ibis				Ibis
FREEHUB MECHANISM	6-Pawl, 6-Phase / 115-Tooth Drive Ring				4-Pawl / 36-Tooth Drive Ring				4-Pawl / 36-Tooth Drive Ring
FREEHUB ENGAGEMENT	.52° / 690 Points of Engagement (POE)				10°				10°
DRIVER	Sram XD Shimano Microspline Shimano 11 Spd.				Sram XD Shimano Microspline Shimano 11 Spd.	- - Shimano 11 Spd.	Sram XD Shimano Microspline Shimano 11 Spd.		- - Shimano 11 Spd.
BEARINGS / QTY.	Enduro / x4				Enduro / x4				Enduro / x4
DISC ROTOR MOUNT TYPE	Center Lock				6 Bolt				6 Bolt

\*ERD measured with Park sticks and using .25mm thick nipple washers. \*\*D = Drive Side, ND = Non-Drive side

	<b>ALUMINUM LOGO</b>			
<b>RIMS &amp; WHEELSETS</b>	<b>S35 / 27.5</b>	<b>S35 / 29</b>	<b>733</b>	<b>933</b>
WHEEL SIZE	27.5"	29"	27.5"	29"
OUTER WIDTH (MM)	39	39	33	33
INNER WIDTH (MM)	35	35	29	29
RIM WEIGHT (G)	505	540	455	490
RIM MATERIAL	6061 Aluminum		6066 Aluminum	
DRILLING	32°			
TYPE	Tubeless			
WHEELSET WEIGHT (G)	1810	1880	1720	1820
SECTION HEIGHT	18.3	18.35	19.5	19.5
SPOKE OFFSET (MM)	5	5	2.5	2.5
SPOKES	Sapim D-Light			
CROSS	3	3	3	3
SPOKE LENGTH (MM)**	274	293	273	292
ERD (MM)	565	602	563	599
THRU AXLE OPTIONS	15x110 / 148x12		12x100 / 142x12	15x110 / 148x12
MAX RIM PRESSURE	40			
FEATURES	5mm Asymmetric Welded Black Ano / Laser Engraved Stan's BST Mounting		2.5mm Asymmetric Welded Black Ano / Laser Engraved Tool Free Tire Mounting	
<b>HUBS</b>	<b>S35 / 27.5</b>	<b>S35 / 29</b>	<b>733</b>	<b>933</b>
BRAND	Ibis			
FREEHUB MECHANISM	4-Pawl / 36-Tooth Drive Ring			
FREEHUB ENGAGEMENT	10°			
DRIVER	XD - Shimano 11 Spd.			
BEARINGS / QTY.	Enduro / x4			
DISC ROTOR MOUNT TYPE	6 Bolt			



## BIKE SET-UP TIPS AND TRICKS

### HEADSETS

The headset on the Ripmo, Ripley, Mojo HD5, and Mojo 3 is a ZS44/ZS56. This standard is compatible with both the Chris King InSet 2 and certain Cane Creek headsets.

Headset on the DV9 is the ZS44/EC49. This standard is compatible with both the Chris King InSet 3 and certain Cane Creek headsets.

The Hakka MX uses an IS41/IS52.

To learn more about these various headset standards, visit: [www.bicycleheadsets.com](http://www.bicycleheadsets.com).

### REAR DROPOUTS AND DISC BRAKE MOUNTS

All of our mountain bikes use the boost standard and our own Hexle axles, removable with a 5mm allen wrench.

#### For Brakes:

- 160mm post-mount is standard on Ripley, Ripmo, Ripmo AF, Mojo 3 and DV9
- 180mm on HD5

Use a post mount adapter for larger rotors, Shimano has a handy guide here: <https://productinfo.shimano.com/#/com?cid=C-460&acid=C-193>

### BOTTLE CAGE

Our rear suspension equipped bikes have been designed around the Arundel side loader cage (available in our online store). Other cages may not provide adequate bottle clearance for the shock and frame so use of the Arundel cage is highly recommended.

There are two sets of holes in the cage, use the ones that position it away from the seat tube.

There are two heavy duty Riv-Nut inserts on the underside of the down tube of the *large and extra large* Mojo 3, to allow the mounting of a bottle cage. We've put them there primarily for a spare water bottle, a tool kit or for a battery if you're night riding.

Please do not attempt to retrieve a water bottle from this cage location during riding!

### GENERAL FRAME INFORMATION CARE FOR CARBON

The carbon fiber monocoque frame is extremely strong, and should provide years of trouble-free use, provided you care for it properly and don't overly huck every 50 foot gap you see.

Keep your bike clean and inspect it often. Although each and every bike gets tested at the factory for strength, it never hurts to look at the areas where the tubes join, where the shocks and dropouts mount and any other areas that may receive stress during usage. Check for loose bearings, headsets, shocks and forks and such. Visually inspect the bike before each ride and also during each cleaning.

### CARBON ASSEMBLY COMPOUND

This stuff is grease, but with a bunch of tiny plastic beads added. This increases friction between components, great for holding your carbon seat post or handlebars in place without excessive clamping force. While grease won't hurt any of our seat tubes, carbon assembly paste works even better. Do not use

the carbon assembly compound when installing the headset, bottom bracket, shock, water bottle cage, or anything that has bearings.

### PAINT AND DECALS

Should you need to touch up areas of the frame where the paint has been compromised, we have touch up paint in our online store for several of our bikes: <http://store.ibiscycles.com> and search paint.

For colors not found in our store, we recommend either a hobby shop, [myperfectcolor.com](http://myperfectcolor.com) or [testors.com](http://testors.com) as a good source of enamel touch up paint.

We try to make our frame finishes as durable as possible, but it is impossible to test in all conditions and against all chemicals. Be aware that use of certain cleaners, lubricants, or foodstuffs, including Simple Green and Pedro's Bike Lust, may damage the paint. Please note that paint damage is not covered under the warranty. Clean any of our frames with mild soap and water only.

Note that paint damage from removal of protective tape is not covered under our paint warranty. Most protective tape manufacturers have recommended removal instructions to prevent paint damage. These usually involve, among other things, applying a little heat to soften the adhesive. Check with the manufacturer of the tape before attempting removal!





### **FORK SET-UP INFORMATION**

Read this first for a general understanding of fork set-up or skip straight to the air pressure charts (page 41) if you just want to go ride.

#### **POSITIVE PRESSURE**

This is the main air spring that supports your weight. Adjust the air pressure so that you come close to using all the travel on a typical ride. Usually you can mimic your maximum impacts by grabbing the front brake and pushing down **HARD** on the bars. If you are getting 80–90% of the fork's travel doing this, your positive air spring is in the right range. Actual riding will often push the fork a little further than this test.

#### **LOW SPEED COMPRESSION DAMPING**

Low speed compression damping is used to reduce unwanted movement and over travel due to low speed changes like out of the saddle pedaling and subtle variations in the trail that can cause wallowing etc. It also helps control frame geometry change during braking and cornering. Adjust to your preference.

---

#### **IMPORTANT NOTE ABOUT FORKS ON ALL OUR BIKES**

For the best possible performance, be sure you are using the proper offset fork.

**DV9:** 51mm

**Ripley, Ripmo, Ripmo AF, Mojo 3:** 44mm

**Mojo HD5:** 37mm

---

#### **LOCKOUT**

As the name implies this turns the fork rigid (or close to it) for out of the saddle efforts or riding on the road. Most forks have a “blowoff” so that the fork will move if a large enough impact is felt. The threshold or “blowoff” when the lockout lets the fork start to move is often adjustable. It's called Gate in Rock Shox parlance and Blowoff Threshold in Fox's language. Usually the goal is to have the lockout at the minimum setting needed to stop the fork movement while pedaling out of the saddle, but allowing it to still move fairly easily when an impact is felt.

#### **HIGH SPEED COMPRESSION DAMPING**

If your fork has a high speed compression damping control, this would usually be used to slow things down during big hits to avoid bottoming. It would usually be set at the lowest level needed to avoid bottoming out.

#### **REBOUND**

Adjust the rebound so that the front end does not bounce off the ground after a drop off or large bump. If adjusted too slow, the fork may “pack down” and feel sluggish. In order to conserve momentum and remain compliant the suspension needs to recover fairly quickly and push off the back side of bumps and holes. If the rebound is adjusted too slow, rolling energy is lost to damping and vibration. If it is adjusted too fast the bike will bounce after bumps and drops. Adjust to your preference.

## FORK SET-UP

With the advent of our Traction Tune philosophy of suspension setup, we are now recommending two different methods of setting sag.

1. For the shorter travel bikes, we recommend setting sag using the traditional method in the seated position: *Sit on your bike in a normal riding position, bouncing up and down a couple times to seat the suspension. Reach down and slide the o-ring up the shock shaft against the wiper seal. Next, gently step off of the bike taking care not to further compress the suspension.*
2. For the more gravity oriented bikes, the HD5 and the Ripmo, please see the standing method of setting sag on [page 40](#).

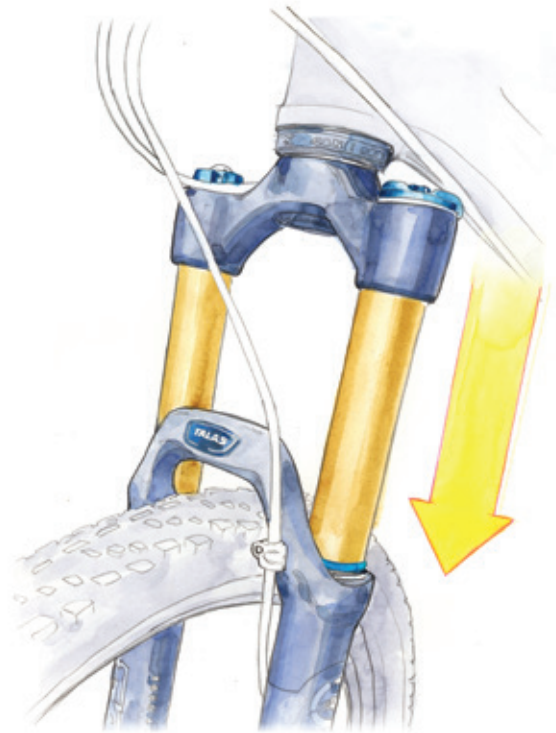

# SETTING SAG

## STEP 1

Add recommended air for rider weight (see charts on following pages). On any fork with a lever, make sure to set sag with the compression lever in the OPEN mode. With bike on level ground, bounce up and down a bit to overcome shock stiction. Settle into your riding position.

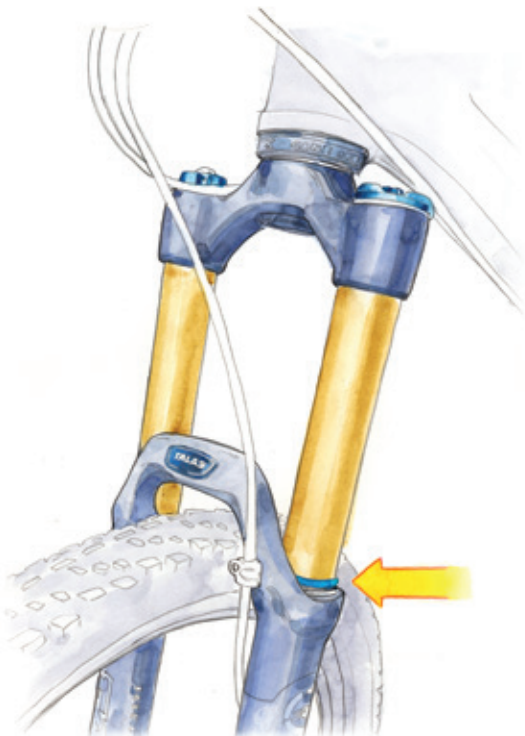

**STEP 2**

Slide o-ring until it rests on wiper, then dismount without disturbing o-ring's position.

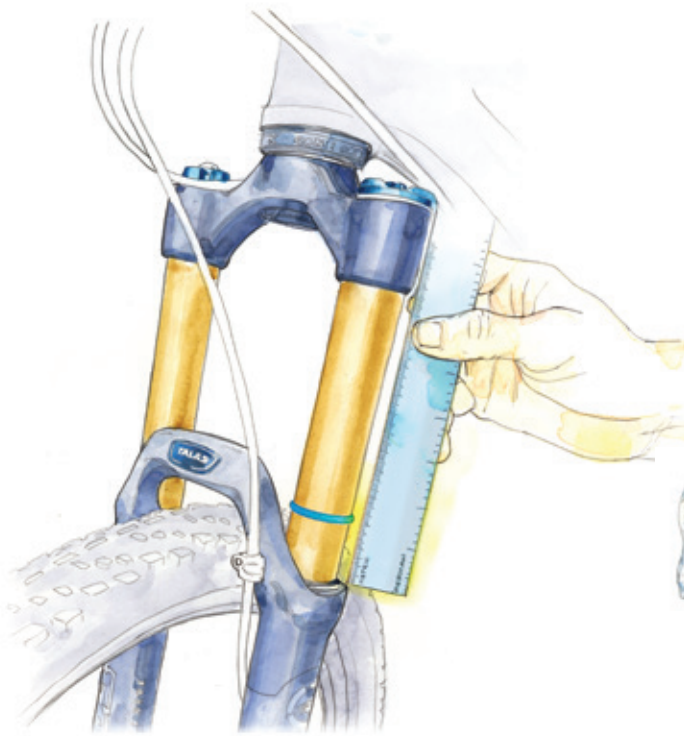

**STEP 3**

Measure sag—the distance from o-ring to wiper. Start with the amount of sag recommended for your bike and riding style (listed on the next page) and adjust to your preference.

IBIS' HANDY SAG MEASURER IN MILLIMETERS



## FORK SETUP

### GETTING THE MOST OUT OF TRACTION TUNE: RIPMO & HD5

For maximum traction and performance, your front and rear suspension need to be balanced. To achieve proper balance, you need to setup your suspension so it matches your style and the steepness of your terrain. *Here is the recommended procedure to get the most out of your suspension.\**

#### STEP 1

Set the front and rear sag with your riding gear on while in a standing position (see illustration), refer to the chart on [page 54-55](#) for rear sag settings in mm. The standing sag method is a little unorthodox, but yields a more balanced suspension setup.

**28% Sag:** Best for normal trail riding where efficient pedalling and a stable platform is required.

**30% Sag:** For aggressive riding in terrain that demands your attention.

**32% Sag:** Use for rough, steep, slippery trails when maximum control is a must.

\*For the Ripley and Mojo 3, use the standard method of setting sag as described on [page 38](#).

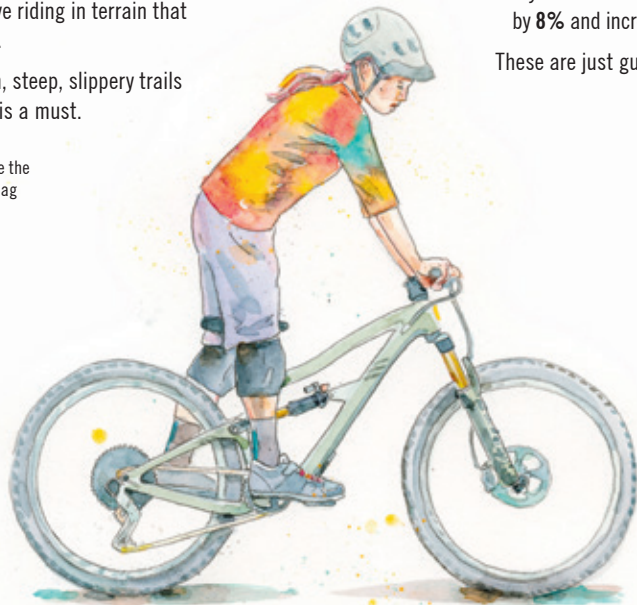

#### STEP 2

Once you've set your sag, it's best to balance your suspension for different types of riding.

- If your normal descent is **10-15%** down grade, use recommended pressures.
- If your normal descent is **20-25%** down grade, reduce **rear shock** pressure by **4%** and increase **fork** pressure by **4%** over recommended pressure.
- If your normal descent is **30+%** down grade, reduce **rear shock** pressure by **8%** and increase **fork** pressure by **4%** over recommended pressure.

These are just guidelines, we recommend experimentation to get the best results.

---

### TRACTION TUNE TROUBLESHOOTING

**Problem: Fork too stiff.** If the fork is too stiff relative to the rear, the head angle is artificially too slack and the bike becomes a handful to get into or out of a corner. Solution: Drop fork pressure or increase rear pressure.

**Problem: Fork dives.** If the fork is diving too much or you are getting a lot of pressure on your feet, then the rear may be too stiff relative to the front. Solution: While it's tempting to stiffen the front, sometimes the solution is to soften the rear.

---

Using the pressures on the charts below as a starting point, adjust air pressures up or down until you get to these recommended starting sag numbers:

**SEATED METHOD** Ripley: 26mm Mojo 3: 28mm DV9: 20mm

**STANDING METHOD** Ripmo/Ripmo AF: 45mm HD5: 48mm



**FOX FLOAT 36 : 27.5 / 29\***

RIDER WEIGHT 160MM & 170MM		
LB	KG	PSI
120-130	54-59	50
130-140	59-64	54
140-150	64-68	59
150-160	68-73	62
160-170	73-77	66
170-180	77-82	70
180-190	82-86	75
190-200	86-91	80
200-210	91-95	84
210-220	95-100	88
220-230	100-104	92
230-240	104-109	97
240-250	109-113	101
MAX		120

**FOX FLOAT 34 : 27.5 / 29\***

RIDER WEIGHT 140MM		
LB	KG	PSI
120-130	54-59	58
130-140	59-64	63
140-150	64-68	68
150-160	68-73	72
160-170	73-77	77
170-180	77-82	82
180-190	82-86	86
190-200	86-91	91
200-210	91-95	96
210-220	95-100	100
220-230	100-104	105
230-240	104-109	110
240-250	109-113	114
MAX		120

**FOX RHYTHM 34 : 29**

RIDER WEIGHT 120MM		
LB	KG	PSI
120-130	54-59	58
130-140	59-64	63
140-150	64-68	68
150-160	68-73	72
160-170	73-77	77
170-180	77-82	82
180-190	82-86	86
190-200	86-91	91
200-210	91-95	96
210-220	95-100	100
220-230	100-104	105
230-240	104-109	110
240-250	109-113	114
MAX		120

**FOX STEPCAST 32: 29\***

RIDER WEIGHT 100MM		
LB	KG	PSI
120-130	54-59	65
130-140	59-64	70
140-150	64-68	74
150-160	68-73	80
160-170	73-77	85
170-180	77-82	90
180-190	82-86	96
190-200	86-91	101
200-210	91-95	106
210-220	95-100	111
220-230	100-104	117
230-240	104-109	122
240-250	109-113	126
MAX		140

**▲ DO NOT EXCEED MAXIMUM AIR PRESSURES | \*Air pressures above are for both Factory and Performance forks from Fox.**



**DVO DIAMOND : 29**

RIDER WEIGHT 160MM		
LB	KG	PSI
120-139	54-63	90-100
140-159	64-72	100-110
160-179	73-81	110-125
180-199	82-90	125-130
200-219	91-100	130-135
220-239	100-108	135-140
240+	109+	140-170

For detailed DVO base tune, see [page 48](#)



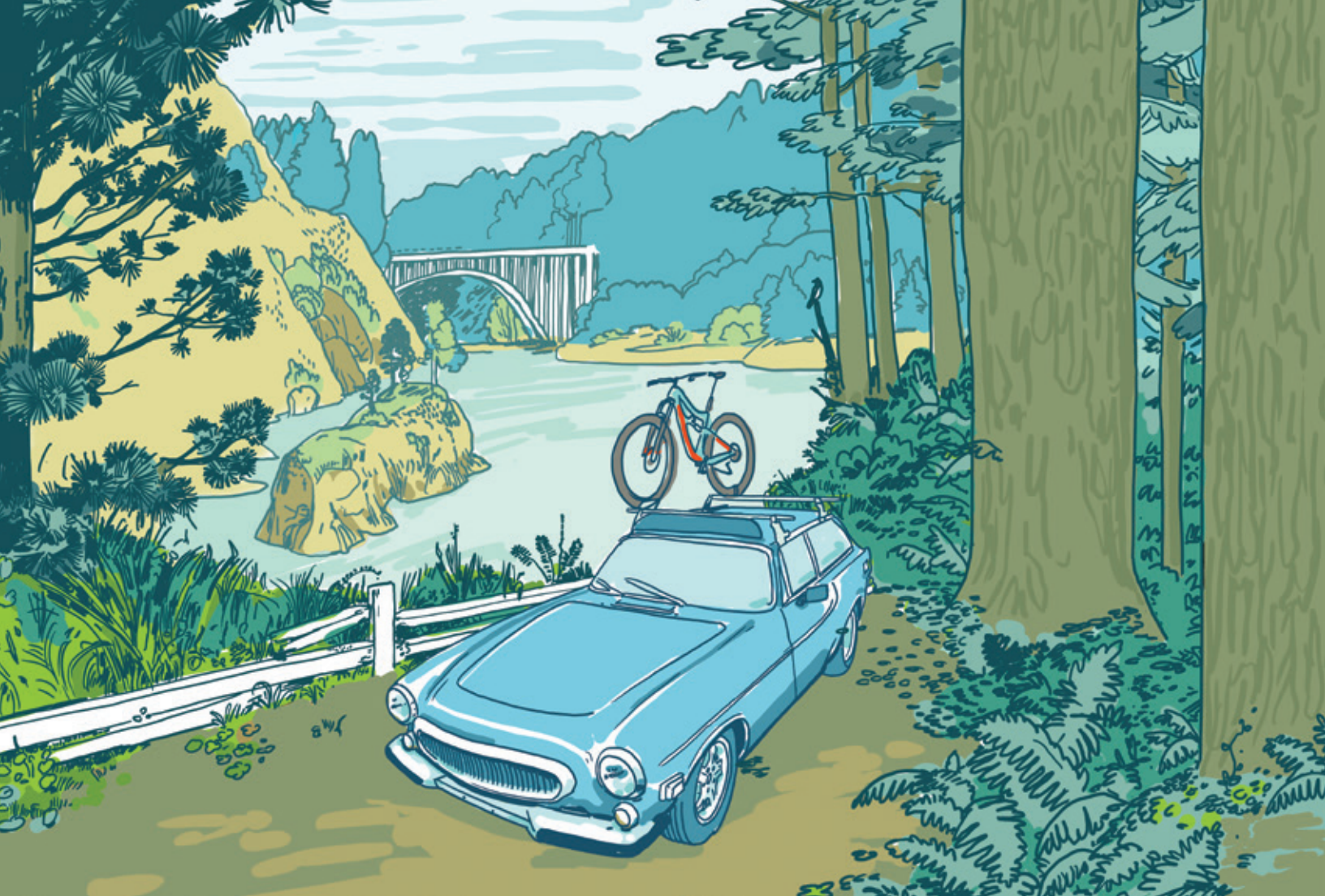

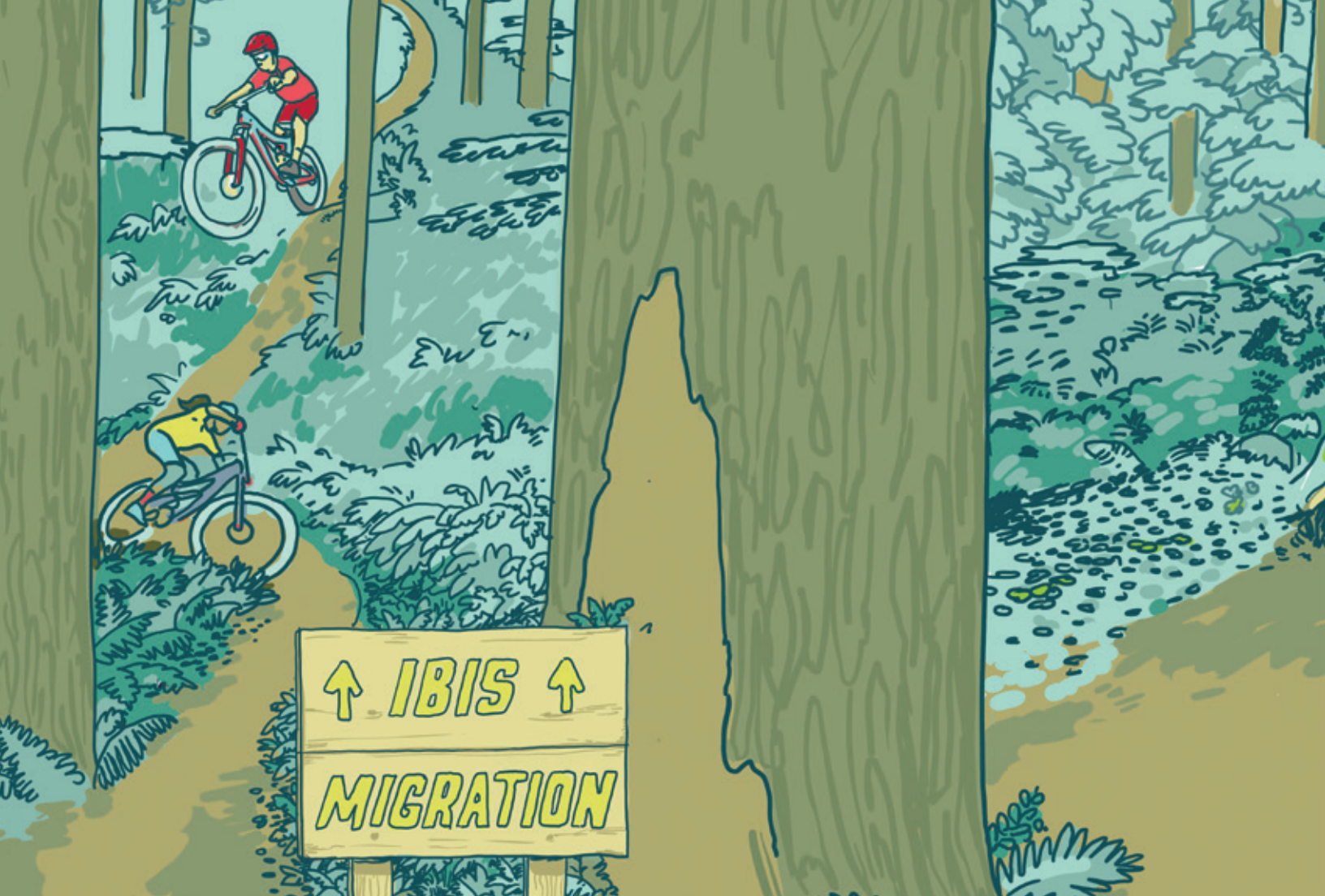

↑ IBIS ↑

MIGRATION

**FORK SET-UP**



**FOX 36 TRACTION TUNE: RIPMO & HD5**



**FOX 36 FACTORY SERIES  
GRIP2 COMPRESSION ADJUSTERS**

Use this diagram as a starting point for your compression adjusters.

Turn your compression adjusters to the closed position (full clockwise) until they stop. Then back them out (counter-clockwise) to the number of clicks shown below.



**High-Speed Compression** adjustment is useful to control fork performance during bigger hits, landings, and square-edged bumps.



**Low-Speed Compression** adjustment is useful to control fork performance during rider weight shifts, G-outs, and other slow inputs.

**FOX 36 PERFORMANCE SERIES  
GRIP MICRO ADJUST**

The Performance Series 36 has a Grip damper with 3-position micro adjust. The lever has a full range of compression adjustment that increases as you turn the lever clockwise, combining low and high speed damping adjustment. As the lever is rotated clockwise from fully open, the damper adds low speed compression damping, then starts adding high speed compression damping and finally goes into lockout. You can access the full range on the fly. Start in the open position and adjust clockwise from there to counteract bob or increase damping control.

**TRACTION TUNE: FLOAT 36 FACTORY GRIP 2**

CLICKS FROM CLOSED

PRESSURE	HSC	LSC	HSR	LSR
40	16	12	8	10-12
45	16	12	8	10-12
50	16	10-12	8	8-12
55	14-16	10-12	8	8-12
60	14-16	8-12	7-8	8-12
65	14-16	8-12	7-8	6-10
70	12-16	8-12	7-8	6-10
75	12-16	8-12	6-8	6-10
80	12-16	8-12	6-8	4-10
85	12-16	6-10	6-8	4-10
90	10-16	6-10	5-8	4-10
<b>RANGE</b>	<b>0-16</b>	<b>0-12</b>	<b>0-8</b>	<b>0-12</b>

**FOX FLOAT 36 PERFORMANCE GRIP**

CLICKS FROM CLOSED

PRESSURE (PSI)	COMPRESSION	REBOUND
40	Open	13
45	Open	13
50	Open	12-13
55	Open	12-13
60	Open	12-13
65	Open	10-13
70	Open	10-13
75	Open	10-13
80	Open	8-13
85	Open	8-13
90	Open	8-13
	<b>SWEEP</b>	<b>RANGE 0-13</b>

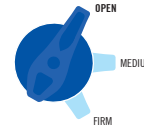

The 3-Position Micro Adjust lever is useful to make on-the-fly adjustments to control fork performance. Use the positions between the OPEN, MEDIUM, and FIRM modes to fine-tune your compression damping.

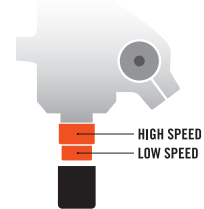

**Fox 36 Rebound Adjusters.** Rebound controls the rate of speed at which the fork extends after compressing.



**FOX 34 COMPRESSION DAMPING SETTINGS**



**FOX 34 FACTORY SERIES  
FIT4 COMPRESSION ADJUSTERS**

Use this diagram as a starting point for your compression adjusters.

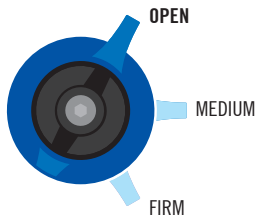

The **3-position lever** is useful to make on-the-fly adjustments to control fork performance under significant changes in terrain, and is intended to be adjusted throughout the ride.

Use the **OPEN** mode during rough descending, the **MEDIUM** mode for undulating terrain, and the **FIRM** mode for smooth climbing.

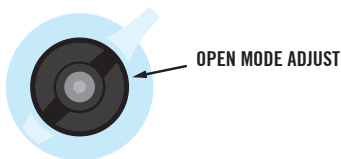

**OPEN mode adjust** is useful to control fork performance under rider weight shifts, G-outs, and slow inputs. **OPEN** mode adjust provides 22 additional fine tuning adjustments for the **OPEN** mode.

Setting 18 will have a more plush feel and setting 1 will have a firmer feel.



**FOX 34 PERFORMANCE SERIES  
GRIP MICRO ADJUST**

The Performance Series 34 has a Grip damper with 3-position micro adjust. The lever has a full range of compression adjustment that increases as you turn the lever clockwise, combining low and high speed damping adjustment. As the lever is rotated clockwise from fully open, the damper adds low speed compression damping, then starts adding high speed compression damping and finally goes into lockout. You can access the full range on the fly. Start in the open position and adjust clockwise from there to counteract bob or increase damping control.

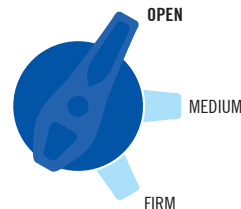

The **3-Position Micro Adjust** lever is useful to make on-the-fly adjustments to control fork performance. Use the positions between the **OPEN**, **MEDIUM**, and **FIRM** modes to fine-tune your compression damping.

The **2-Position Sweep Adjust** (34 Rhythm forks on DV9 only) lever is useful to make on-the-fly adjustments to control fork performance. Use the positions between **OPEN** and **FIRM** modes to fine-tune your compression damping.

## FORK SET-UP

**REBOUND SETTINGS**  
**FOX 34 : 27.5 / 29**

RIDER WEIGHT (LBS)	RECOMMEND REBOUND SETTINGS FIT4	RECOMMEND REBOUND SETTINGS GRIP
120-130	14	13
130-140	13	12
140-150	12	11
150-160	11	10
160-170	9	9
170-180	8	8
180-190	7	7
190-200	6	6
200-210	5	5
210-220	4	4
220-230	3	3
230-240	2	2
240-250	1	1
<b>RANGE</b>	<b>0-14</b>	<b>0-13</b>

Turn your rebound knob to the closed position, clockwise until it stops. Then turn it counter-clockwise to the number of clicks shown in the table above.

**REBOUND SETTINGS**  
**FOX 32 : 29**

RIDER WEIGHT (LBS)	RECOMMEND REBOUND SETTINGS FIT4
120-130	14
130-140	13
140-150	12
150-160	11
160-170	9
170-180	8
180-190	7
190-200	6
200-210	5
210-220	4
220-230	3
230-240	2
240-250	1
<b>RANGE</b>	<b>0-14</b>

**FOX 34 / 32**  
**REBOUND ADJUSTERS**



Rebound controls the rate of speed at which the fork extends after compressing.

**A NOTE ON TUNING GUIDES**

Tuning Guides for current and legacy Fox forks and shocks can be found at [ridefox.com](http://ridefox.com). While our info here is thorough, Fox has even more detail on their support pages. We recommend you check it out.

As an FYI, here's the GRIP info:  
<http://www.ridefox.com/help.php?m=bike&id=690#adjustinggripcompressiondamping>

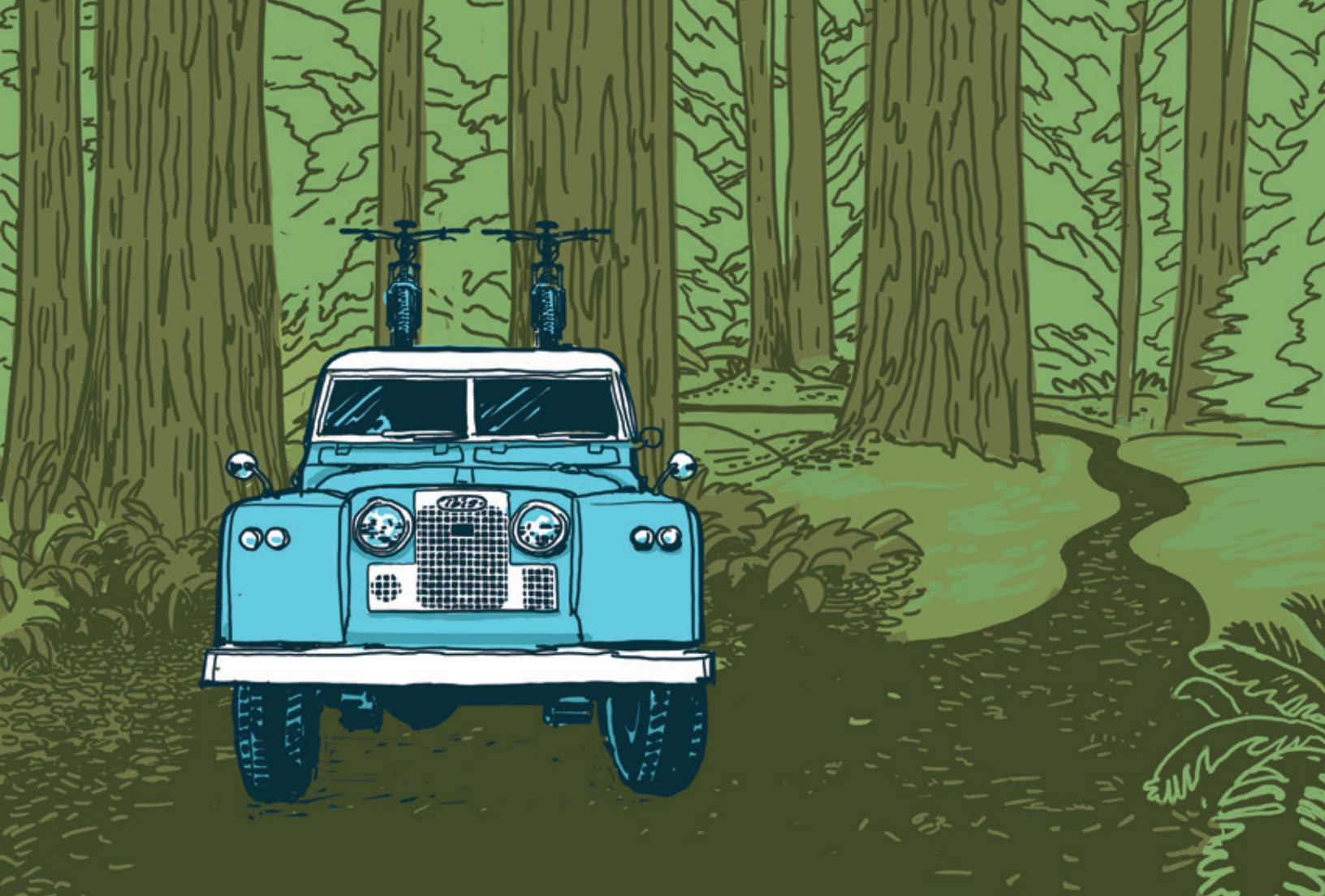



**FORK SET-UP****DVO DIAMOND  
RIPMO AF FORK SET UP**

The DVO Diamond features adjustable high and low speed compression damping, adjustable rebound damping, and Off the Top (OTT), which adjusts the initial sensitivity of the travel.

For even more detailed tuning instructions, go to <http://tech.dvosuspension.com/setup/diamond/>

**DVO****DVO DIAMOND : 29**

RIDER WEIGHT		160MM					
LB	KG	PSI	OTT	REBOUND	HSC	LSC	
120-139	54-63	90-100	0-2 rotations	10-14 clicks	0-1 clicks	1-2 clicks	
140-159	64-72	100-110	2-4 rotations	10-14 clicks	0-2 clicks	1-2 clicks	
160-179	73-81	110-125	3-7 rotations	8-12 clicks	2-3 clicks	1-2 clicks	
180-199	82-90	125-130	6-8 rotations	8-12 clicks	2-4 clicks	1-2 clicks	
200-219	91-100	130-135	7-9 rotations	6-10 clicks	3-5 clicks	1-2 clicks	
220-239	100-108	135-140	8-10 rotations	6-10 clicks	6-10 clicks	1-2 clicks	
240+	109+	140-170	8-10 rotations	6-10 clicks	6-10 clicks	1-2 clicks	

**Air Pressure Range:** 90-170psi

**OTT Range:** 6 clicks = 1 full rotation. 14 full rotations total.

**Rebound Range:** 20 clicks total

**High Speed Compression (HSC) Range:** 29 clicks total

**Low Speed Compression (LSC) Range:** 6 clicks total

Compression is adjusted at the top of the right fork leg, rebound at the bottom. Air pressure is adjusted at the top of the left fork leg and OTT at the bottom.

When setting up your compression and OTT, start from Wide-Open (turn the adjuster counter-clockwise until it stops). The Compression and OTT adjustments above refer to making adjustments clockwise from the Wide-Open setting.

When setting up your rebound, start from fully closed (knob turned all the way clockwise). The rebound adjustment above refers to making adjustments counter-clockwise from the Fully-Closed setting.

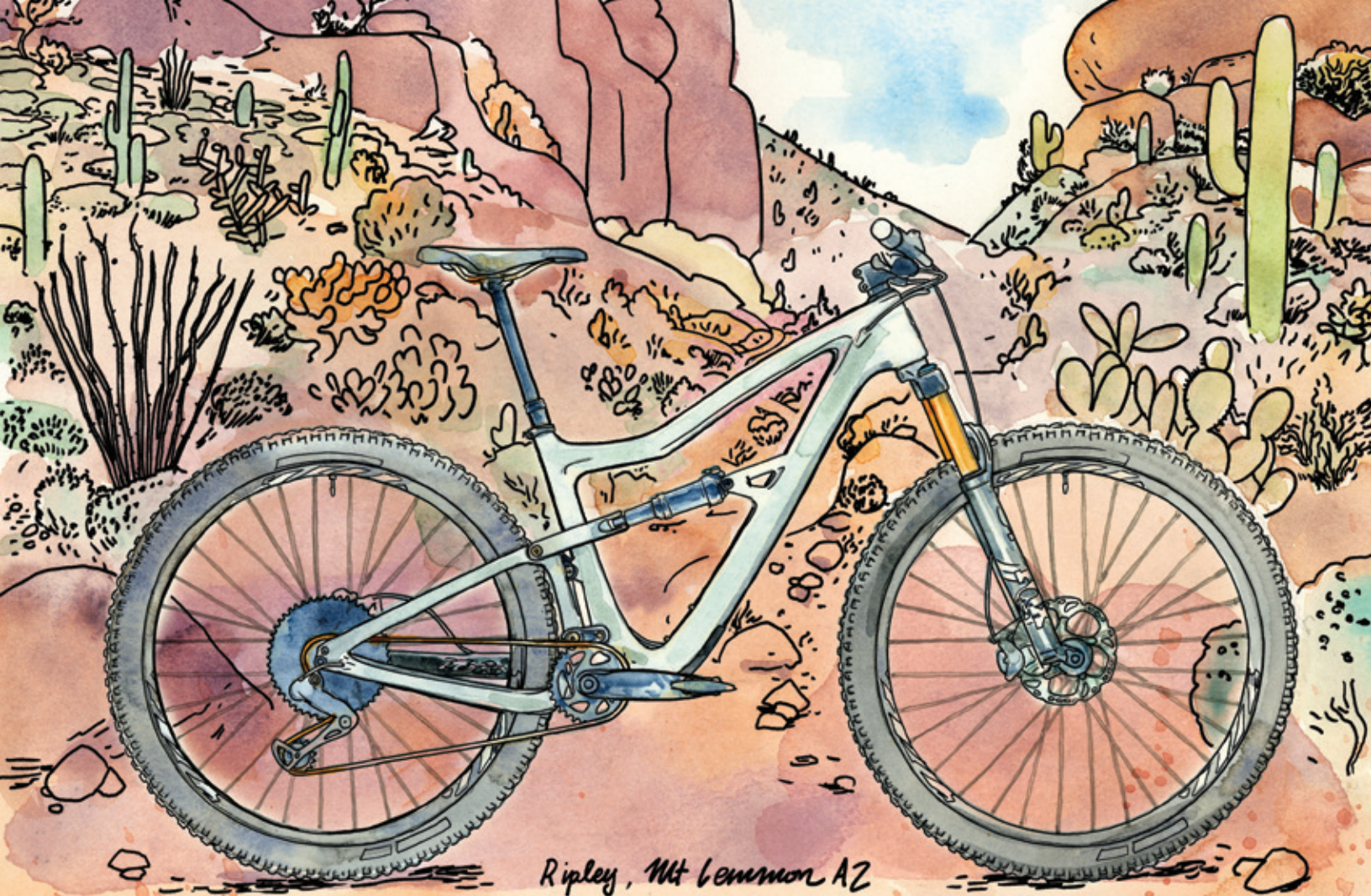

Ripley, Mt Lemmon AZ

## REAR SHOCK SET-UP

**SETTING SAG**

Recommended beginning pressures can be found on [page 52-55](#). Set the pressure and follow the instructions on this page for setting the sag. Less pressure gives a slacker seat angle and overall smoother ride. More pressure gives a firmer suspension feel and steeper seat angle and more over the pedals riding position.

**Ripmo / Ripmo AF**

Start with ~14mm of sag

**Mojo HD5**

Start with ~15mm of sag

**Ripley**

Start with ~11mm of sag

**Mojo 3**

Start with ~11mm of sag

**CHECK THE SAG**

With the shock in open mode (or ProPedal turned off for earlier shocks), use the recommended seated or standing method and recommended starting pressure. Reach down and slide the o-ring up the shock shaft against the wiper seal. Next, gently step off of the bike taking care not to further compress the suspension.

For the **Ripley and Mojo 3**, the distance from the o-ring to the wiper seal should be about 11mm.

On the **Ripmo**, sag should be about 14mm for trail and 15–17mm for gravity rides.

On the **Mojo HD5**, sag should be about 15mm for Trail and 16–17mm for gravity rides.

Experiment and see what works best for your trails and riding style.

**FOX FLOAT DPS**

There's a 3 position on-the-fly (lever) adjustment like before. They control low speed compression damping. They're called **Open-Medium-Firm**. The **Open** mode is the tunable one. That enables you to adjust the mode that you use most often, then have the preset **Medium** and **Firm** modes if you want to firm things up for fire road climbing or pavement (we rarely use these settings on our bikes).

**ADJUSTING REBOUND**

The Float DPS has adjustable rebound damping. It's adjusted by turning the red dial on the inside of the lever. Generally you want it as fast as you can set it without getting bounced off the saddle after a bump or drop (like riding off a curb in the saddle.) If the rebound setting is too slow the shock will be partially compressed when you hit the next bump resulting in "packing down". Too fast and the bike will bounce you up in the air after bumps and drops. Adjust to your preference.

## **SHOCK AND SHOCK HARDWARE SPECIFICATIONS**

Our suspension bikes have the following shock and shock hardware specifications:

### **Ripley Shock**

- Upper: 25mm wide with an 8mm bore
- Lower: 15mm wide with an 8mm bore
- 190mm eye to eye
- 45mm shaft travel

### **Ripmo/Ripmo AF Shock**

- Upper: 25mm wide with an 8mm bore
- Lower: 15mm wide with an 8mm bore
- 210mm eye to eye
- 55mm shaft travel

### **Mojo HD5 Shock:**

- Upper: 21.8mm wide with an 8mm bore
- Lower: 15mm wide with an 8mm bore
- 7.875" (200mm) eye to eye
- 2.25" (57mm) shaft travel

### **Mojo 3 Shock:**

- Upper: 21.8mm wide with an 8mm bore
- Lower: Bushing removed, 15mm bore
- 7.875" (200mm) eye to eye
- 2" (51mm) shaft travel

## **SETTING AIR PRESSURE FOR THE FIRST TIME WITH THE NEGATIVE AIR CHAMBER SLEEVE**

On Fox shocks, it is critically important to add or remove air from the negative air chamber sleeve as detailed below to experience the best possible performance.

**IMPORTANT NOTE:** When adding air to the air chamber, it is crucial to equalize the positive and negative air chambers by slowly compressing the shock through 25% of its travel 10-20 times after every 50psi addition.

Adding air to the shock without periodically equalizing the air chambers can lead to a condition in which the shock has more pressure in the positive chamber than the negative. In this condition the shock will be very stiff and can top-out. You can equalize the air chambers by slowly compressing the shock until you feel and hear a transfer of air. Hold the shock at this point for a few seconds to allow the air to transfer from the positive to the negative chamber.

When releasing air from the air chamber, it is important to do this slowly so the shock can transfer air from the negative to positive chamber and then be released through the Schrader valve.

Releasing the air pressure too quickly can induce a condition in which the negative chamber has more pressure than the positive chamber. In this condition the shock will compress into its travel and not fully extend. You can remedy this by adding air pressure until the shock extends, then slowly compressing the shock through 25% of its travel 10-20 times.



**REAR SHOCK AIR PRESSURE CHARTS : STARTING PRESSURES FOR SETTING SAG****DVO JADE X**

DVO worked with our National Enduro Team and our engineers to come up with a damping profile to match the new Ripmo AF kinematics.



The Jade X features a 3 position compression adjuster that allows the rider to choose from full open (descending) mid position (single track or climbing) to near lock out for the 3rd position.

They also came up with a new rebound damping profile that has built in low speed rebound during the initial part of the suspension movement, keeping the bike feeling composed and balanced. The middle part of the rebound stroke (the sweet spot) allows for rapid movement which keeps the rear wheel tracking the ground without packing down and the end of stroke slows down again reducing the possibility of getting bucked during jumps or larger impacts.

**REAR SHOCKS****DVO JADE X : RIPMO AF****COIL SPRING WEIGHT GUIDE**

RIDER WEIGHT LB	SPRING WEIGHT LB
140-155	350
155-170	400
170-185	450
185-200	500
200-215	550
215-230	600

**NOTE: Ripmo AF ships with the following standard coil springs**

Small:	350
Medium:	400
Large:	450
X-large:	500

The Topaz has a three position compression damping switch. As with all of our dw-link bikes, we prefer to run them WFO (wide open) and let the dw-link do it's magic.

For rebound, adjust to personal preference, as outlined on [page 37](#).

**DVO TOPAZ : RIPMO AF****27.5% SAG / 14MM**

RIDER WEIGHT LB	PRESSURE PSI
120-130	112-123
130-140	123-134
140-150	134-144
150-160	144-155
160-170	155-166
170-180	166-177
180-190	177-187
190-200	187-198
200-210	198-209
210-220	209-220
220-230	220-230
230-240	230-241
240-250	241-252

**REAR SHOCKS****FOX DPS : RIPLEY**

**25% SAG** - Shoot for .45" (~11mm) of sag.

RIDER WEIGHT LB	PRESSURE PSI
100	130
120	150
140	170
160	190
180	210
200	240
220	270
250	310

**MAX 350 PSI!**

**FOX DPS : MOJO 3**

**25% SAG** - Shoot for .47" (~12mm) of sag.

RIDER WEIGHT LB	PRESSURE PSI
100	120
120	140
140	160
160	200
180	200
200	230
220	260
250	300

**MAX 350 PSI!**

**Note: For riders under 120lbs on the Mojo 3, we offer the Roxy Tune shock (but it is not required!).**



ibis

Mojo 3  
Flow Trail  
Soquel, CA

**REAR SHOCK AIR PRESSURE CHARTS : STARTING PRESSURES FOR SETTING SAG****IMPORTANT NOTE ABOUT SUSPENSION SETTINGS ON ALL OUR BIKES**

These are Ibis recommended settings and differ from FOX recommended settings.

**TRACTION TUNED****FOX X2 : HD5****FOX DPX2 : HD5**

HD5 SAG	28% WHEEL SAG = 15mm SHOCK STROKE	30% WHEEL SAG = 16mm SHOCK STROKE	32% WHEEL SAG = 17mm SHOCK STROKE	28% WHEEL SAG = 15mm SHOCK STROKE	30% WHEEL SAG = 16mm SHOCK STROKE	32% WHEEL SAG = 17mm SHOCK STROKE
RIDER WEIGHT (LBS.)	SHOCK PRESSURE (PSI)	SHOCK PRESSURE (PSI)	SHOCK PRESSURE (PSI)	SHOCK PRESSURE (PSI)	SHOCK PRESSURE (PSI)	SHOCK PRESSURE (PSI)
120 - 130	124	119	113	131	126	118
130 - 140	134	129	123	143	137	130
140 - 150	144	138	133	155	149	142
150 - 160	153	148	142	166	161	153
160 - 170	163	158	152	178	172	165
170 - 180	173	168	162	190	184	177
180 - 190	183	178	172	202	196	189
190 - 200	193	187	182	214	207	201
200 - 210	203	197	191	226	219	213
210 - 220	213	207	201	238	231	225
220 - 230	223	217	211	250	242	237
230 - 240	233	226	221	262	254	249
240 - 250	243	236	231	273	266	260

TRACTION  
TUNED

## FOX X2 : RIPMO

## FOX DPX2 : RIPMO

RIPMO SAG	28% WHEEL SAG = 15mm SHOCK STROKE	30% WHEEL SAG = 16mm SHOCK STROKE	32% WHEEL SAG = 17mm SHOCK STROKE	28% WHEEL SAG = 15mm SHOCK STROKE	30% WHEEL SAG = 16mm SHOCK STROKE	32% WHEEL SAG = 17mm SHOCK STROKE
RIDER WEIGHT (LBS.)	SHOCK PRESSURE (PSI)	SHOCK PRESSURE (PSI)	SHOCK PRESSURE (PSI)	SHOCK PRESSURE (PSI)	SHOCK PRESSURE (PSI)	SHOCK PRESSURE (PSI)
120 - 130	142	137	133	149	142	138
130 - 140	158	153	148	167	160	156
140 - 150	175	168	163	186	179	175
150 - 160	191	184	178	205	198	194
160 - 170	207	199	193	223	216	212
170 - 180	223	215	208	242	235	231
180 - 190	239	231	223	261	254	250
190 - 200	256	246	239	279	272	268
200 - 210	272	262	254	298	291	287
210 - 220	288	277	269	317	310	306
220 - 230	N/A	293	284	336	329	325
230 - 240	N/A	N/A	299	N/A	347	343
240 - 250	N/A	N/A	N/A	N/A	N/A	N/A

**REAR SHOCK AIR PRESSURE CHARTS : STARTING PRESSURES FOR SETTING SAG****FLOAT X2 DAMPER ADJUSTMENTS**

Turn all four damper adjusters to the closed position (full clockwise) until they stop. Then back them out (counter-clockwise) to the number of clicks shown in the table.

**IMPORTANT NOTE:** Be careful not to force the low speed adjusters to the end of their range. Rotating Low Speed Compression (LSC) or Low Speed Rebound (LSR) adjusters to min or max too forcefully can cause them to get stuck. If they do get stuck, use FOX tool 398-00-746 to hold the high speed adjuster in place while loosening the low speed adjuster.

**TRACTION TUNED FOX X2 SHOCK DAMPER BASE SETTING**

CLICKS FROM CLOSED		100319		
PRESSURE (PSI)	HSC	LSC	HSR	LSR
100	20-22	20-22	18-22	20-22
110	20-22	20-22	18-22	20-22
120	20-22	20-22	18-22	20-22
130	20-22	20-22	18-22	20-22
140	20-22	18-20	18-22	20-22
150	18-21	18-20	18-22	19-21
160	18-21	18-20	18-22	19-21
170	18-21	16-18	18-22	19-21
180	18-21	16-18	18-22	19-21
190	16-20	16-18	18-22	19-21
200	16-20	14-16	18-22	19-21
210	16-20	14-16	18-22	17-19
220	16-20	14-16	18-22	17-19
230	15-18	12-14	18-22	17-19
240	15-18	12-14	18-22	15-17
250	15-18	12-14	18-22	15-17
<b>RANGE</b>	<b>0-22</b>	<b>0-22</b>	<b>0-22</b>	<b>0-22</b>

**FLOAT DPK2 REBOUND ADJUSTMENTS**

The rebound adjustment is dependent on the air pressure setting. For example, higher air pressures require slower rebound settings. Use your air pressure to find your rebound setting.

Turn the rebound knob to the closed position (full clockwise) until it stops. Then back it out (counter-clockwise) to the number of clicks shown in the table below.

**TRACTION TUNED FOX DPK2 SHOCK DAMPER BASE SETTING**

CLICKS FROM CLOSED		100319
PRESSURE (PSI)	LSC	LSR
110	Open	10-12
120	Open	10-12
130	Open	10-12
140	Open	10-12
150	Open	10-12
160	Open	10-12
170	Open	10-12
180	Open	10-12
190	Open	10-12
200	Open	10-12
210	Open	10-12
220	Open	10-12
230	Open	10-12
240	Open	10-12
250	Open	9-12
260	Open	9-12
270	Open	8-12
280	Open	8-12
<b>RANGE</b>	<b>LEAVE IT OPEN</b>	<b>0-12</b>

We work closely with the engineers at Fox to custom tune the shocks on each of our bikes. If you are looking to update your Ibis to the latest 2020 Fox suspension, here is all the information you will need, part numbers, descriptions and what you will need to have a Fox trained technician change on your new shock.

Fork aftermarket part numbers for 2020 are included too. Unless noted we use stock tunes on all the forks so no modification is needed.



## AFTERMARKET FORKS

BIKE MODEL	FOX AM P/N	DESCRIPTION
DV9 (100mm w/remote lockout)	910-20-733	2020, 32, K, FLOAT SC, 29in, F-S, 100, FIT4, Remote-Adj, Psh-Unlk, 2Pos, (10pm CP), Matte Blk, Orange/Matte Blk Logo, Kabolt 110, BLK, 1.5 T, 51mm Rake, AM
DV9 (120mm non-remote)	910-20-728	2020, 34, K, FLOAT SC, 29in, F-S, 120, FIT4, 3Pos-Adj, Matte Blk, Orange/Matte Blk Logo, Kabolt 110, BLK, 1.5 T, 51mm Rake, AM
Mojo 3	910-20-783	2020, 34, K, FLOAT, 27.5in, F-S, 140, FIT4, 3Pos-Adj, Matte Blk, Orange/Matte Blk Logo, 15QRx110, 1.5 T, 44mm Rake, AM
Mojo HD5*	910-20-762	2020, 36, K, FLOAT, 27.5in, F-S, 170, Grip 2, HSC, LSC, HSR, LSR, Matte Blk, Orange/Matte Blk Logo, 15QRx110, 1.5 T, 37mm Rake, AM
Ripley 4	910-20-717	2020, 34, K, FLOAT, 29in, F-S, 130, FIT4, 3Pos-Adj, Matte Blk, Orange/Matte Blk Logo, 15QRx110, 1.5 T, 44mm Rake, AM
Ripmo*	910-20-696	2020, 36, K, FLOAT, 29in, F-S, 160, Grip 2, HSC, LSC, HSR, LSR, Matte Blk, Orange/Matte Blk Logo, 15QRx110, 1.5 T, 44mm Rake, AM

\*To match the OEM tune of the Ripmo and HD5 Factory fork, Revalve damper to light rebound (RL)



## AFTERMARKET SHOCKS

BIKE MODEL	FOX AM P/N	DESCRIPTION	NOTES FOR CONVERTING AFTERMARKET DAMPER TO IBIS OEM SPECIFICATION
Mojo 3 Float DPS	972-01-411	2020, FLOAT DPS, F-S, K, 3pos-Adj, Evol LV, FOX, AM, 7.875, 2.0, 0.6 Spacer, LCM, LRM, CMF, Orange Logo	Revalve damper to DCL, DRM, CMF. Install 0.8 cu in air volume reducer.
Mojo 3 Float DPS (Roxly Tune)	972-01-411	2020, FLOAT DPS, F-S, K, 3pos-Adj, Evol LV, FOX, AM, 7.875, 2.0, 0.6 Spacer, LCM, LRM, CMF, Orange Logo	Revalve damper to DCXL, DRL, CMF. Install 0.8 cu in air volume reducer.
Mojo HD5 Float X2	973-01-243	2020, FLOAT X2, F-S, K, 2pos-Adj, Evol LV, FOX, AM, 7.875, 2.25, 0.3 Spacer x2, CM, Orange, Gray Logo	Revalve damper to CL, RL. Remove all air volume reducers
Mojo HD5 Float DPX2	973-01-235	2020, FLOAT DPX2, F-S, K, 3pos-Adj, Evol LV, FOX, AM, 7.875, 2.25, 0.2 Spacer, CM, DRM, Rezi A F F, Orange Logo	Revalve damper to DCXL, DRXL, AFM.
Ripley 4 Float DPS	972-01-432	2020, FLOAT DPS, F-S, K, 3pos-Adj, Evol LV, FOX, AM, 190, 45, 0.4 Spacer, LCM, LRM, CMF, Orange Logo	Revalve damper to LCL, LRM, CMF. Install 0.6 cu in air volume reducer.
Ripmo Float X2	973-01-267	2020, FLOAT X2, F-S, K, 2pos-Adj, FOX, AM, 210, 55, 0.3 Spacer x3, CM, Orange, Gray Logo	Revalve damper to CM, RL. Remove 2 air volume reducers from stock shock (leaving only 1 inside).
Ripmo Float DPX2	973-01-256	2020, FLOAT DPX2, F-S, K, 3pos-Adj, Evol LV, FOX, AM, 210, 55, 0.2 Spacer, CM, DRM, Rezi A F M+, Orange Logo	Revalve damper to DCXL, DRXL, AFM. Install 0.4 cu in air volume reducer. "Rezi A F M" indicates the open mode compression damping is adjustable by 3mm hex wrench instead of the fixed "L" light open mode of the stock Performance Series damper.

## BEARING / BUSHING MAINTENANCE AND REPLACEMENT

### WORKING ON MOJO 3

The linkage assemblies on the Mojo 3 is designed to be removed and replaced easily. Be sure to purchase a fresh link set before removing the old ones to skip any downtime. There are no bearings to press out, nor any axles to hammer. Upper and lower pivot assemblies are available in the buy section of our website, or you can have your dealer order them from Ibis for you. Replacement is super simple and requires these common tools:

- 2x 4mm Allen wrenches
- 2x 6mm Allen wrenches
- 2x 5mm Allen wrenches
- Loctite 243 (or 242) blue thread locker

### REPLACING LINKAGES

Please refer to the section on Mojo 3 Swingarm Removal in this manual on [pages 70-71](#).

### BEARING REPLACEMENT

If you're handy with a bench vice and have a good supply of sockets, you can attempt the replacement of the bearings in the upper and lower link yourself. While we don't have step-by-step instructions, you are welcome to purchase the bearings and try it yourself.

**Note:** *The only way we ever see links damaged is by people trying to replace their bearings. Experts only.*

### MOJO 3 BEARING SPECS

The lower links use DDR1526 bearings on the drive side and 6902rs on the non-drive side. The upper links are 6800rs all around.

### BEARING KITS

Enduro Bearing kits are available for all modern Ibis suspension bikes at <http://www.enduroforkseals.com/id245.html>



**BUSHING SERVICE INTERVALS**

The lower link bushings on our suspension bikes should be checked, cleaned, and serviced after every wet season. In predominantly dry conditions, a longer service interval is acceptable. Under most riding conditions, the lower link bushings will last two or more seasons.

Clevis bushings should be checked, cleaned, and serviced after every wet season. If the majority of riding is in wet weather, the clevis bushing service interval should be performed more often.

In general clevis bushings and o-rings should be replaced once a year. For primarily wet conditions, bushings may need to be replaced more often. In primarily dry conditions, replacement bushings may be needed less often.



FRAME HARDWARE : RIPMO

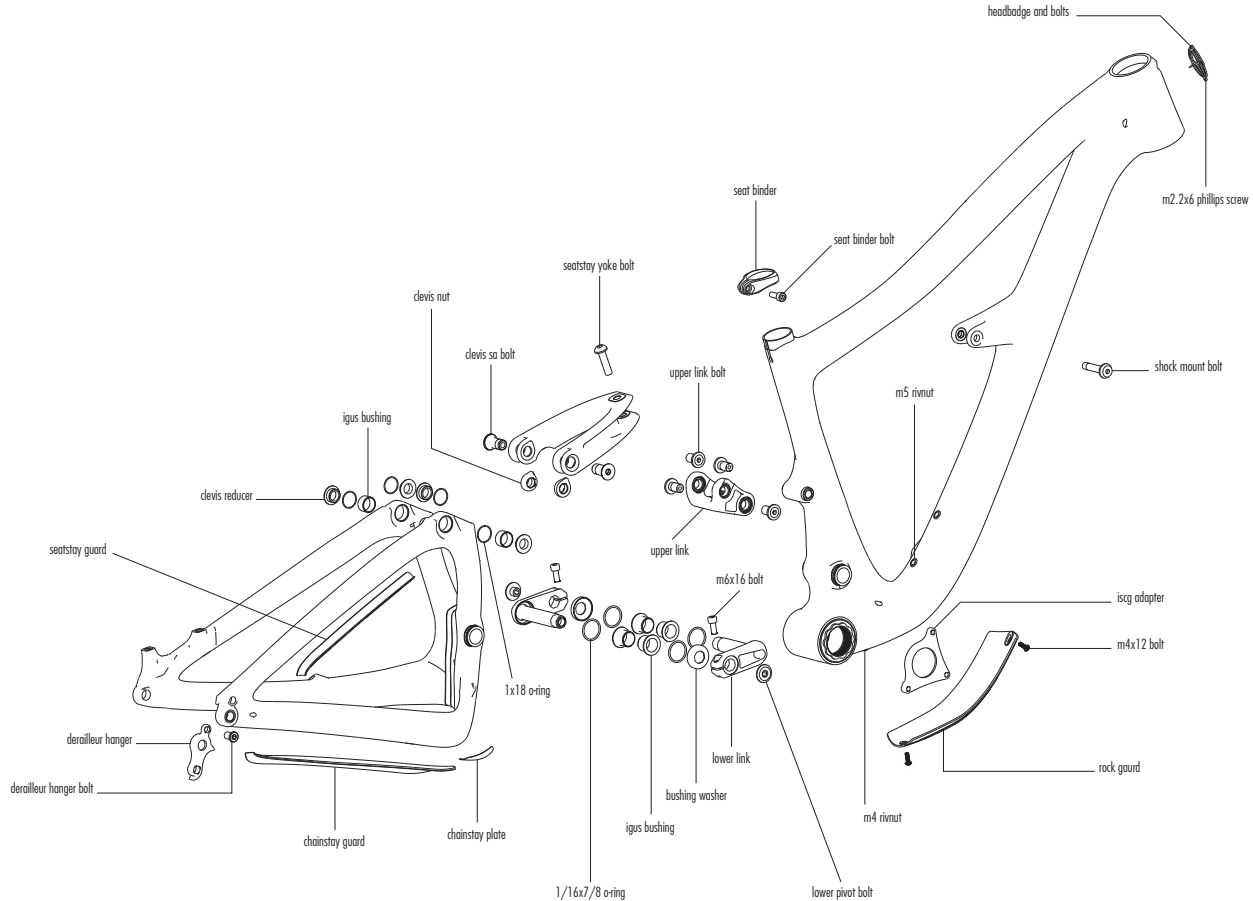

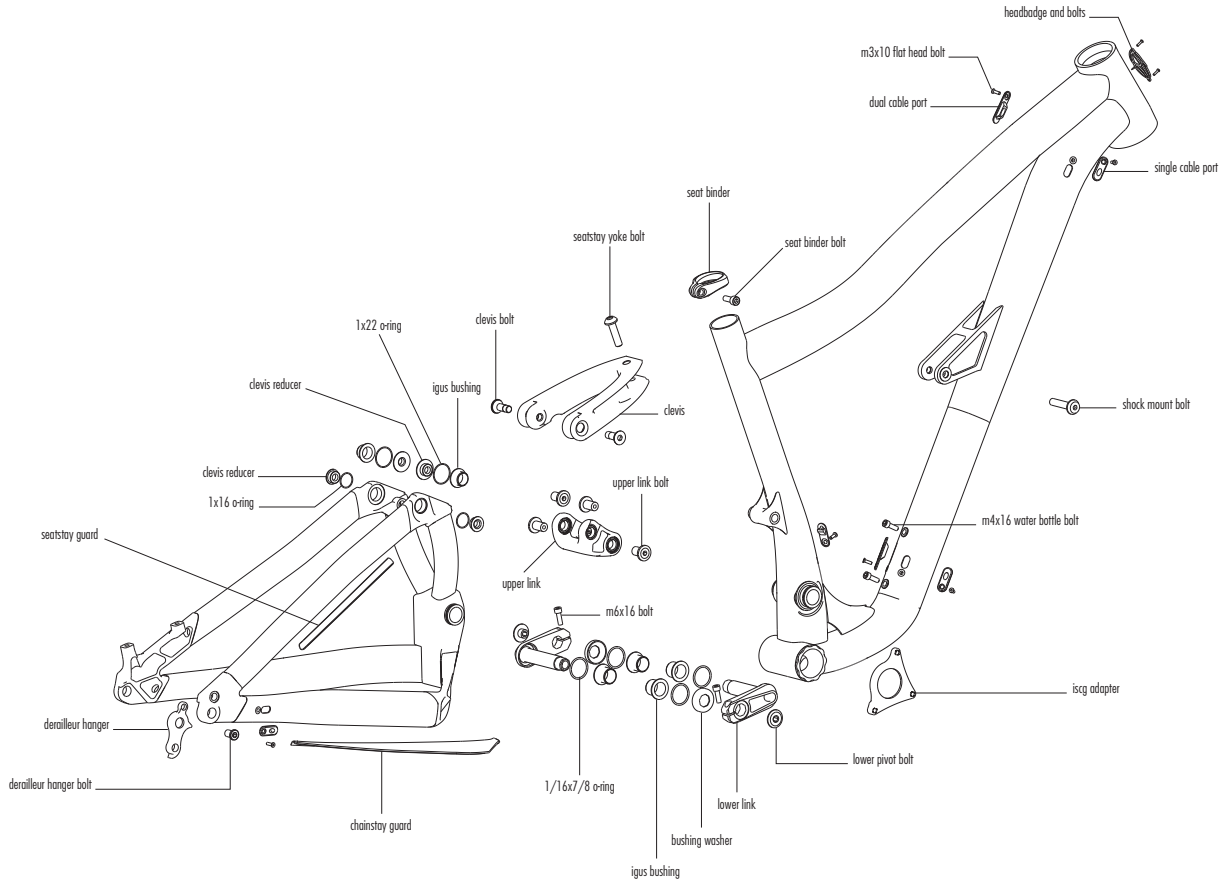

FRAME HARDWARE : RIPLEY

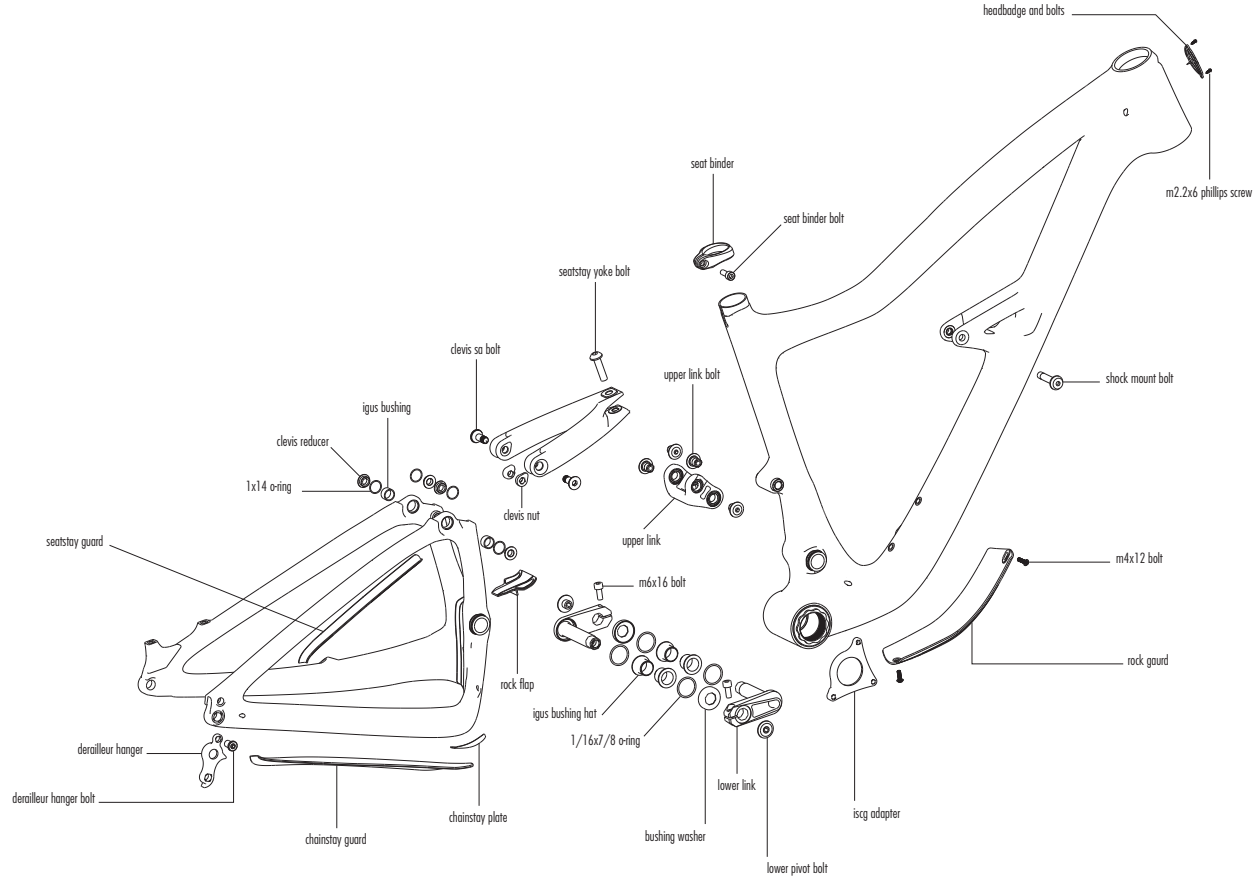

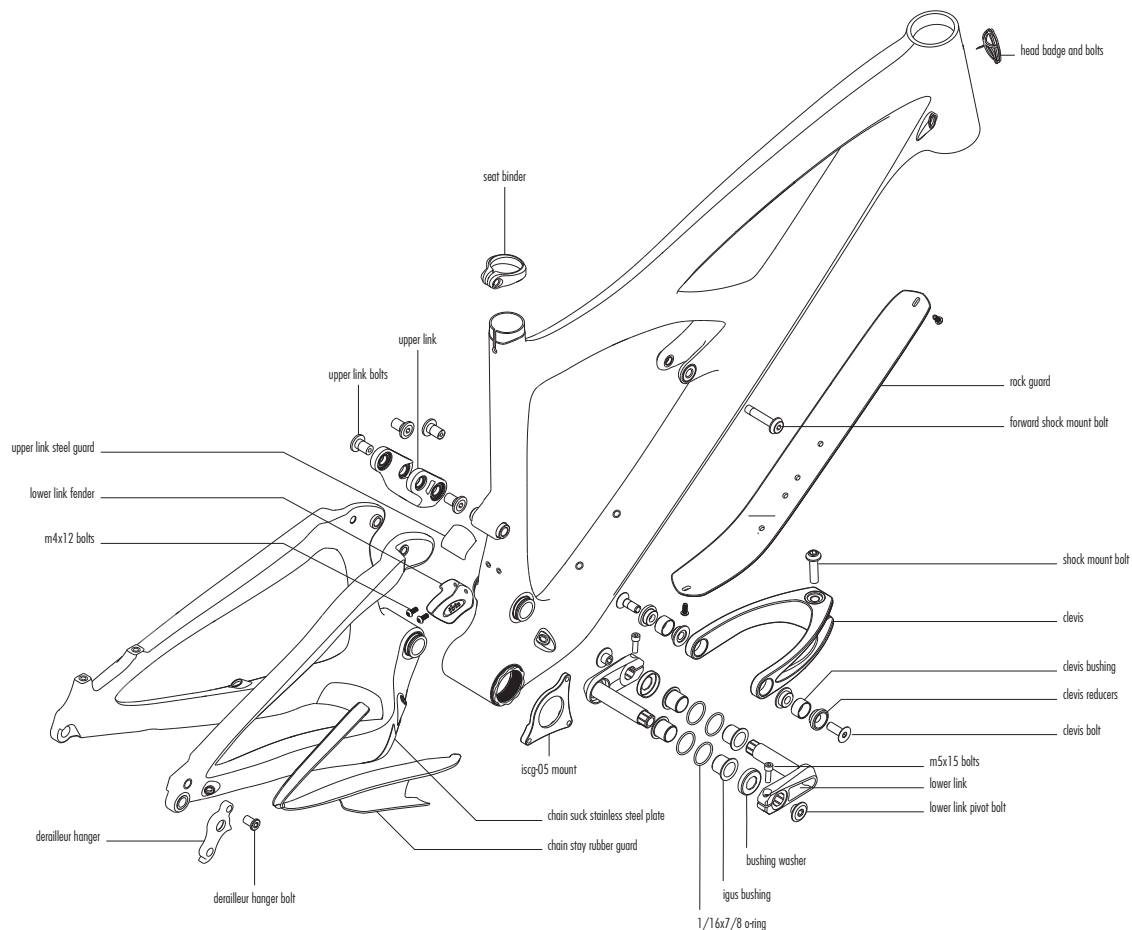

FRAME HARDWARE : MOJO 3

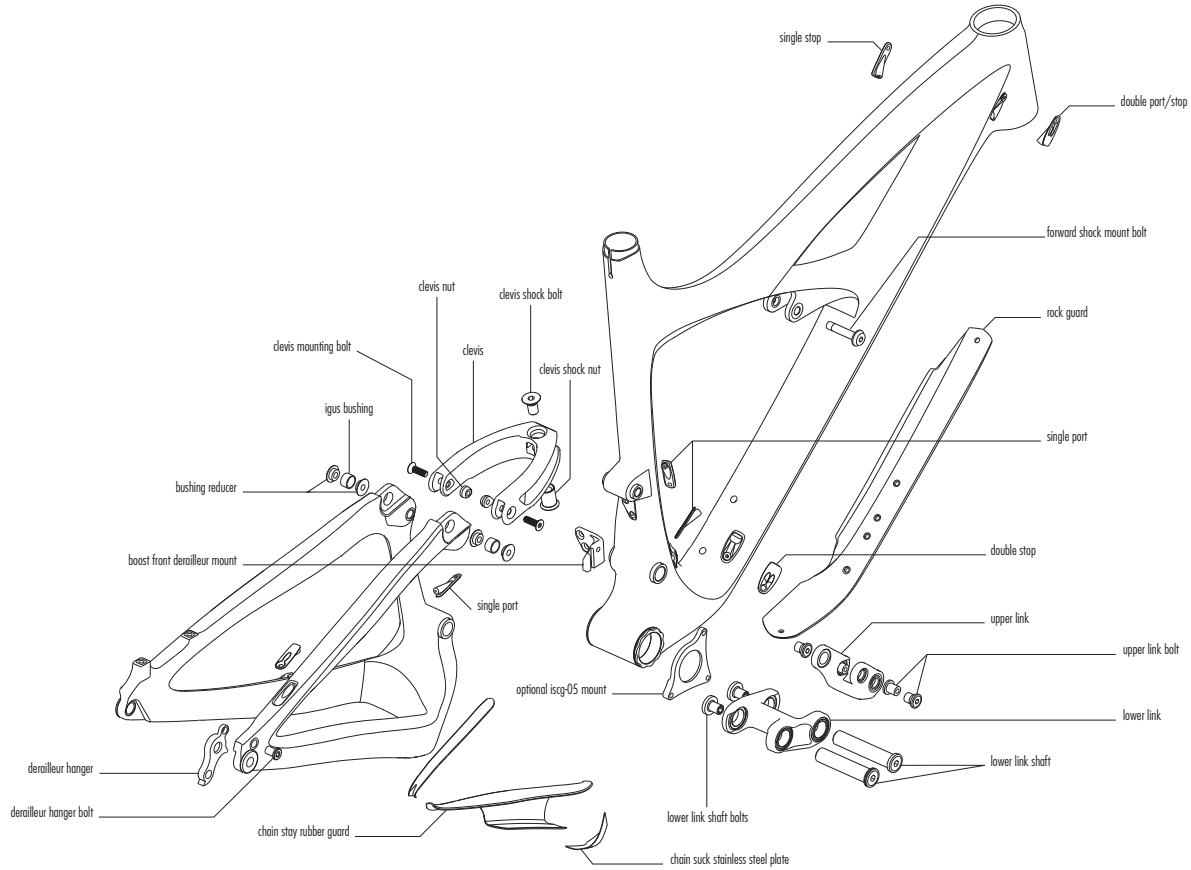



BUTER GAP TR.

LONG BRANCA TR.

TO DAVIDSON RIVER  
ROAD. 27 MILES →

**TORQUE SPECS**

**MOJO 3**

**Note on 243 Loctite:** Shake the bottle well before applying!

HARDWARE	TORQUE SPEC.	THREAD TREATMENT
Cable Port	2 Nm	Grease
Clevis to Swingarm Bolts	8 Nm	Loctite 243
Derailleur Hanger Bolt	5 Nm	Grease
Downtube Rock Guard	2 Nm	Loctite 243
Lower Links	24 Nm	Loctite 243
Lower Shock to Clevis Bolts	24 Nm	Loctite 243 on the threads, grease on the outer diameter of the nut
Rear Brake Caliper	6 Nm	Loctite 243
Seat Binder	5 Nm	Ti anti-seize
Upper Link Bolts	10 Nm	Loctite 243
Upper Shock Mount Bolts	10 Nm	Loctite 243 on threads, grease under head of bolt or mylar washer

**DV9 / HAKKA MX**

HARDWARE	TORQUE SPEC.	THREAD TREATMENT
Battery Door (Hakka MX only)	2 Nm	Loctite 243
Cable Port	2 Nm	Grease
Derailleur Hanger Bolt	5 Nm	Grease
Rear Brake Caliper	6 Nm	Loctite 243
Seat Binder	5 Nm	Ti anti-seize



**HD5 / RIPMO / RIPMO AF / RIPLEY****Note on 243 Loctite:** Shake the bottle well before applying!

HARDWARE	TORQUE SPEC.	THREAD TREATMENT
Cable Ports (Ripmo AF only)	2Nm	Grease
Deraillleur Hanger Bolt	5 Nm	Grease
Downtube Rock Guard (HD5 / Ripmo / Ripley only)	2 Nm	Loctite 243
Forward Shock Mount Bolt	10 Nm	Loctite 243
Lower Link 6mm Preload Bolts	2 Nm	Loctite 243 on threads, grease on flange
Lower Link 5mm Pinch Bolts	10 Nm	Loctite 243
Lower Shock to Clevis Bolt	20 Nm	Ti anti-seize
Swingarm to Clevis Pivot Bolts	10 Nm	Loctite 243
Rear Brake Caliper	6 Nm	Loctite 243
Seat Binder	5 Nm	Ti anti-seize
Upper Link Bolts	10 Nm	Loctite 243

**BUSHINGS**

On all models, apply Slick Honey (grease) to all bushings during reassembly.

**HEXLE REAR AXLE**

There is not a numerical torque figure for the Hexle. We recommend tightening the 5mm with your multi tool that you carry with you. This way you'll be able to remove it in case of a flat out on a ride.



**SWINGARM REMOVAL : HD5 / RIPMO / RIPMO AF / RIPLEY**

**DISASSEMBLY / REASSEMBLY**

Put your freshly cleaned HD5 / Ripmo / Ripmo AF / Ripley in a work stand, remove cranks, and the rear wheel. Follow steps 1-5 for disassembly, and in reverse order for reassembly.

**NOTE:** Assembly and disassembly are the same but the clevis pivot for the Ripmo AF uses a different bushing.

**STEP 1**

Remove the shock and clevis assembly by removing the upper shock mount bolt with a 5mm Allen wrench\*. Next, remove the clevis to swingarm bolts with a 5mm Allen.

*\*On the upper shock mount, be careful not to lose the thin black washers that go on the outside of the shock eyelet.*

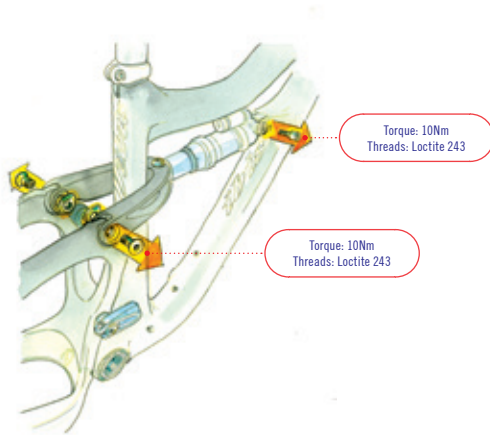

**STEP 2**

Carefully separate the shock and clevis assembly from the frame.

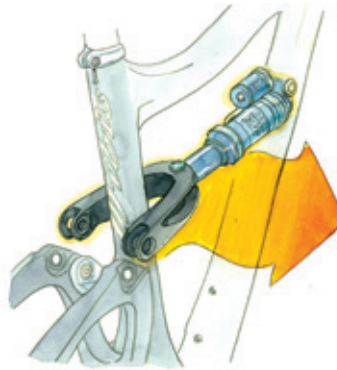

**STEP 3**

Remove the lower shock mount bolt with two 6mm Allens.

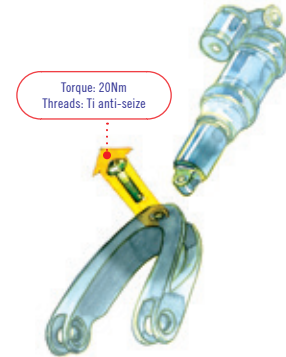

**PRO TIP:** During reassembly, note the torque specs and thread treatments



Torque: 5Nm

We have two video tutorials on both removal and replacement of the Ripmos / Ripleys lower link bushing on our website: [https://www.ibiscycles.com/support/support\\_videos](https://www.ibiscycles.com/support/support_videos)

**STEP 4**

Remove 4 upper link bolts.

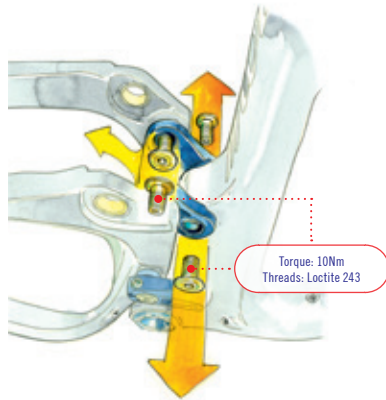

**STEP 5**

Remove upper link from swingarm and front triangle.

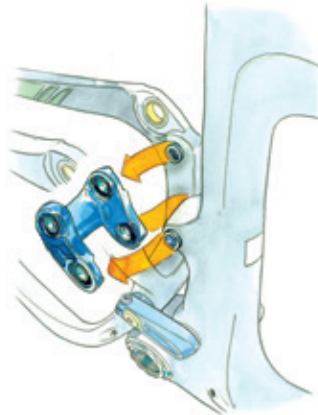

**STEP 6**

Loosen pinch bolts, remove preload bolts. Link is two pieces, to remove pull two sides of link apart while supporting the swingarm.

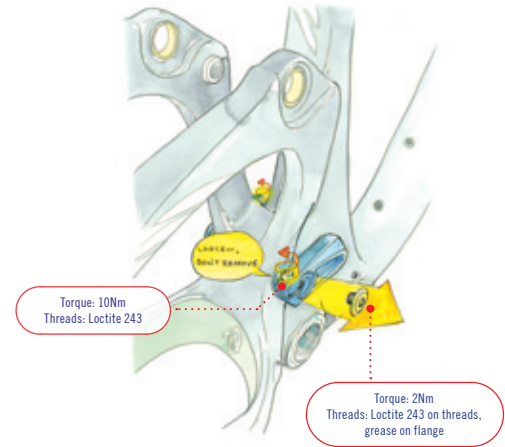

**SWINGARM REMOVAL : MOJO 3**

**DISASSEMBLY / REASSEMBLY**

Put your freshly cleaned Mojo in a work stand, remove cranks, and the rear wheel. Follow steps 1-6 for disassembly, and in reverse order for reassembly.

**PRO TIP:** During reassembly, note the torque specs and thread treatments



**STEP 1**

Remove the shock and clevis assembly by removing the upper shock mount bolt and shaft with two 4mm Allen wrenches\*. Next, remove the clevis to swingarm bolts with a 5mm Allen.

*\*On the upper shock mount, be careful not to lose the thin black washers that go on the outside of the shock eyelet.*

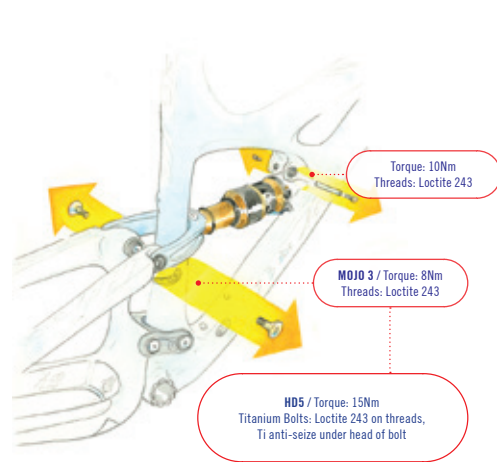

**STEP 2**

Carefully separate the shock and clevis assembly from the frame.

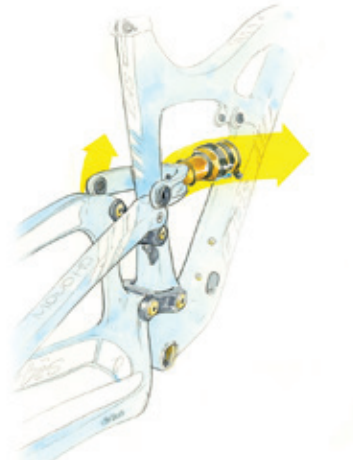

**STEP 3**

Remove the lower shock mount bolt with a 6mm Allen.

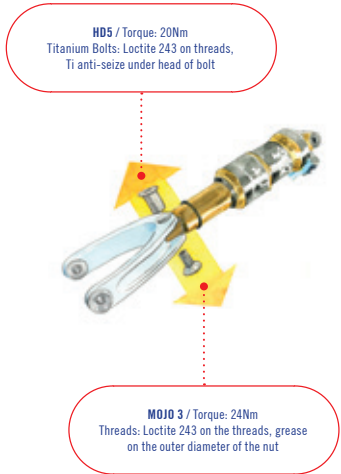

**STEP 4**

Remove front lower link shaft and the two forward upper link bolts.

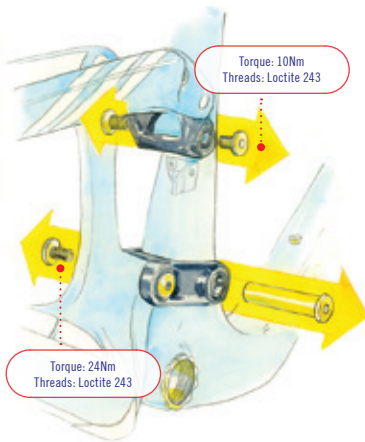
**STEP 5**

Pull the swingarm with the linkages still attached away from the front triangle.

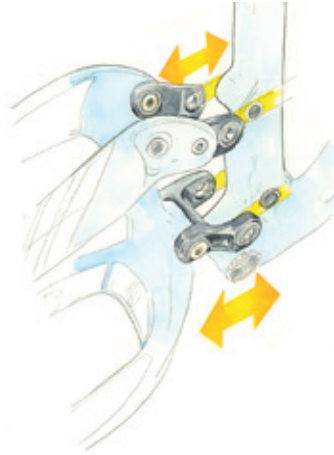
**STEP 6**

Remove the axle in the lower link that passes through the swingarm and separate the link from the swingarm. Also remove the upper link from the swingarm.

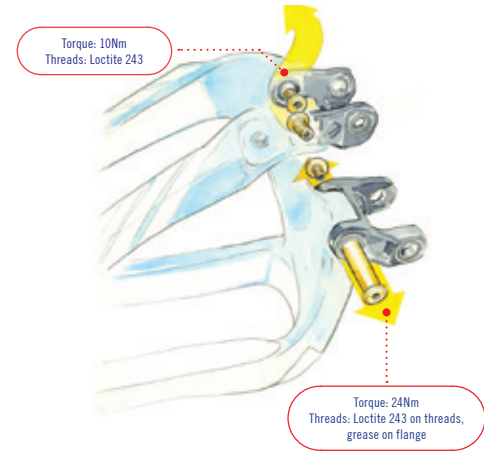

**WARRANTY****FRAME WARRANTY**

7 Year Guarantee - Ibis Frames are guaranteed to be free of defects in materials and workmanship for a period of 7 years for the original owner. Ibis will either repair or replace at its discretion any part it determines to be defective. Paint and finish are covered for a period of 1 year. This warranty is non-transferable and applies exclusively to Ibis bicycles manufactured after January 1, 2016.

Frames manufactured before January 1, 2016, will be covered by this warranty for a period of 3 years for the original owner.

Paint and finish are covered for a period of 1 year. Note that improper removal of protective tape is not covered under our paint warranty. Most protective tape manufacturers have

recommended removal instructions to prevent paint damage. These usually involve, among other things, applying a little heat to soften the adhesive. Check with the manufacturer of the tape before attempting removal!

**RIM WARRANTY**

7 Year Guarantee - Ibis rims are covered from failure due to impact damage under normal riding circumstances for a period of 7 years. This warranty is non-transferable and applies exclusively to Ibis rims manufactured after January 1, 2016

Ibis branded hubs are guaranteed to be free of defects in materials and workmanship for a period of 2 years for the original owner.

**NO FAULT REPLACEMENT**

Should your Ibis product be involved in a crash or other non-warranty situation, Ibis Cycles will make replacement parts available at a minimum charge to the original owner for the life of the product. Ibis Cycles does this at its sole discretion and reserves the right to refuse this offer.

**SMALL PRINT**

The above limited warranties do not cover normal wear and tear, nor does it apply to damage that is the result of blatant abuse, neglect, improper assembly, improper maintenance, alteration, misuse, or heat

damage (watch that exhaust pipe). The costs of disassembly, reassembly or repair of any attached components are not covered by this warranty and are the responsibility of the original owner. Under no circumstance are the costs of shipping to or from Ibis covered by these warranties.

Unless otherwise provided, the sole remedy under the above warranties, or any implied warranty, is limited to the replacement of defective parts with those of equal or greater value at the sole discretion of Ibis Cycles. In no event shall Ibis Cycles be held responsible for direct, incidental or consequential damages, including, without limitation, damages for personal injury, property damage, or economic losses, whether based on contract, warranty, negligence, product liability, or any other theory. Okay? Good!



**WARRANTY REGISTRATION**

Don't forget to register your warranty online at:  
[http://www.ibiscycles.com/support/warranty/warranty\\_registration/](http://www.ibiscycles.com/support/warranty/warranty_registration/)

The Fox forks and shocks we use on our bikes are warranted for one year. For USA Warranty Service:  
**(800) FOX-SHOX / 369-7469**  
 or [service@foxracingshox.com](mailto:service@foxracingshox.com)

**For International Warranty Service**

Contact a Fox service center:  
<http://www.ridefox.com/fox17/contact.php?r=worldwide&ref=service>

**PARTS**

Find these online at the buy portion our website or get them directly from your Ibis dealer. Contact us or your dealer for more info. We recommend you always ride with one or two spare derailleur hangers.

**SERIAL NUMBER**

We recommend you write down your serial number for future reference. The serial number is located under the bottom bracket.

**BIKE INFO**

MODEL : \_\_\_\_\_

PAINT COLOR : \_\_\_\_\_

FRONT TRIANGLE SERIAL NO. \_\_\_\_\_

SWINGARM SERIAL NO. \_\_\_\_\_

**SHOCK SETTINGS**

PSI : \_\_\_\_\_

CLICKS REBOUND: \_\_\_\_\_

CLICKS COMPRESSION: \_\_\_\_\_

TUNING NOTES: \_\_\_\_\_

**FORK SETTINGS**

PSI : \_\_\_\_\_

CLICKS REBOUND: \_\_\_\_\_

CLICKS COMPRESSION: \_\_\_\_\_

TUNING NOTES: \_\_\_\_\_

Specifications and construction details given are not binding. We reserve the right to carry out modifications without prior notice.

**CHUCK'S RECIPE****IMPRESS YOUR RIDING BUDDIES WITH  
CHUCK'S HOMEMADE ENERGY BARS****INGREDIENTS**

- 1/2 cup salted almonds
- 1/2 cup roasted sunflower seeds, or other chopped nuts
- 2 cups raisins, or other chopped dried fruit
- 2 cups rolled or instant oats
- 2 cups toasted rice cereal, such as Rice Krispies
- 1/4 cup toasted wheat germ, (optional)
- 1/2 cup creamy or crunchy natural almond butter
- 1/2 cup packed brown sugar
- 1/2 cup honey (or agave sweetener)
- 1 teaspoon vanilla extract

**PREPARATION**

- 1.** Coat a 9-by-13-inch baking pan with cooking spray.
- 2.** Combine the almonds, sunflower seeds (or other nuts), raisins (or other dried fruit), oats, rice cereal and wheat germ (if using) in a large bowl.

- 3.** Combine almond butter, brown sugar and corn syrup (or honey) in a large microwaveable bowl; microwave on High until bubbling, 1 to 2 minutes. Add vanilla and stir until blended. Pour the almond butter mixture over the dry ingredients and stir until coated.
- 4.** Transfer the mixture to the prepared pan. Press down firmly. (It helps to coat your fingers with cooking spray.) Let stand for about 1 hour to harden. Cut into bars.

**TIPS AND NOTES**

**Make Ahead Tip:** Individually wrap and keep at room temperature for up to 1 week or freeze for up to 1 month. Thaw at room temperature. Makes 16 Bars, better than Method Man in his prime.

**NUTRITION**

Per serving: 255 calories; 9g fat (1g sat., 2g mono); 0 mg cholesterol; 42g carbohydrates; 5g protein; 3g fiber; 95mg sodium; 242mg potassium.



**TOLL FREE** (formerly called an 800 number but all 800's are used up we guess)  
1-866-424-7635 (1-866-IBIS-635)

**NOT TOLL FREE** (unless maybe you're at work)  
1-831-461-1435 (Or if you're all fancy and internationally  
savvy: +1-831-461-1435)

**ELECTRONIC MAIL** (sometimes referred to as "email")  
[askchuck@ibiscycles.com](mailto:askchuck@ibiscycles.com)

**FAX** (remember those?) 1-831-461-1475

**REALLY OLD FASHIONED SNAIL MAIL**  
2240 Delaware Ave. Santa Cruz, CA 95060.

**IBISCYCLES.COM**

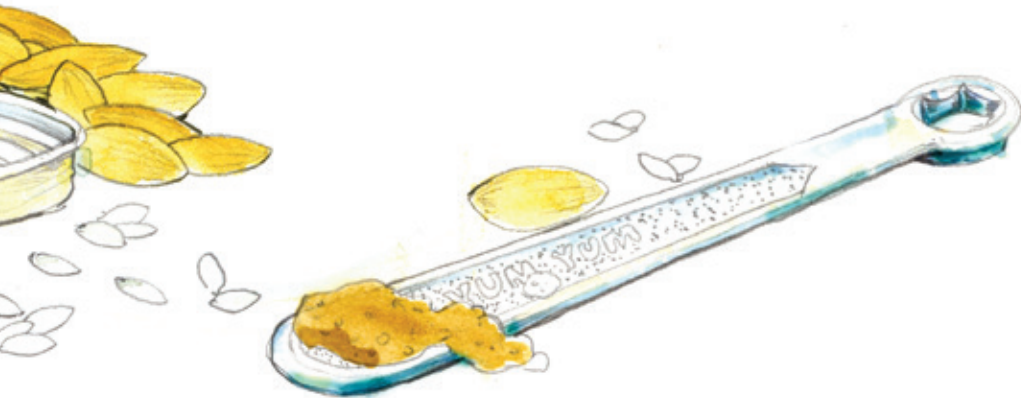

**ALPHABETICAL INDEX**

Airstream	2-3	Introduction	2
Bearing Specs, Mojo	58	ISCG 05	4-6, 17
Bottle Cage	36	Peanut Butter Wrench	75
Cable Routing	10-30	Rear Shock Air Pressure Chart	52
Cannoli	30	Rear Shock Tuning	50-56
Chuck's Recipe	74	Serial Number	73
Fork Set-up	37-48	Snail Mail	75
Fox Grip2 Settings	44-45	Stack and Reach	4-6
Frame Care	36	Swingarm Removal	68-71
Frame Hardware Drawings	60-64	Torque Specs	66-67
Geometry	4-7	Warranty	72-73
Hand Job	79		





Evolution  
of the  
Opener



Whatever  
Was Around...



the  
Hand Job



On the  
Trail



Standard



Single  
Speed



Das  
Liberator

Maximus ~ not pictured







***ibiscycles.com***